

NORSE 2023 buoy

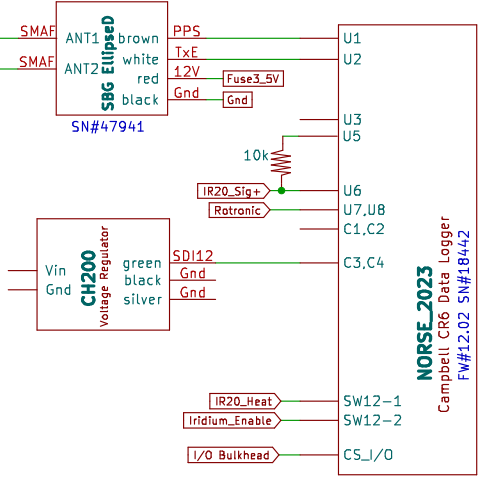
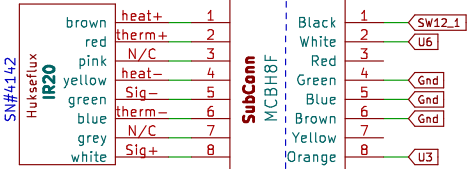
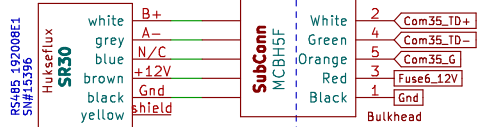
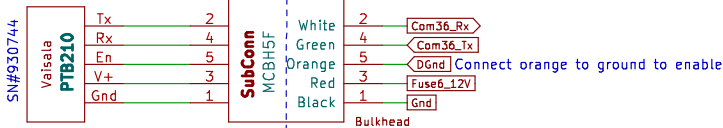
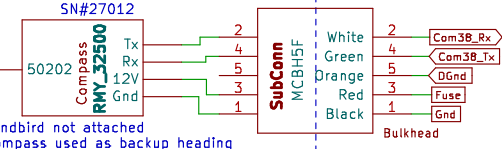
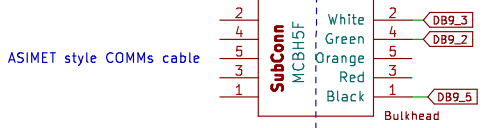
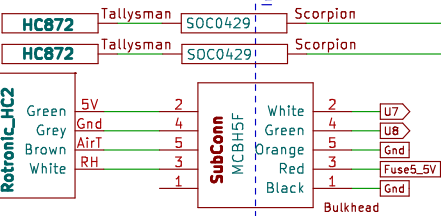
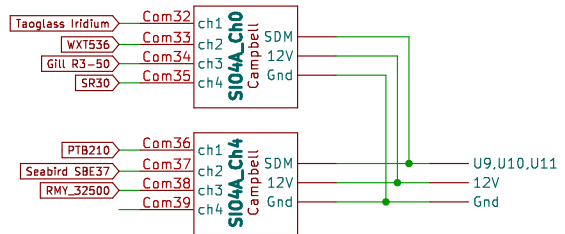
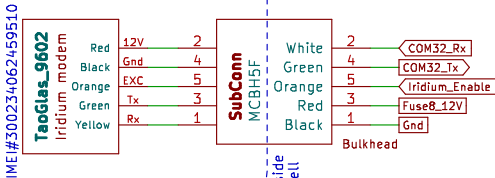
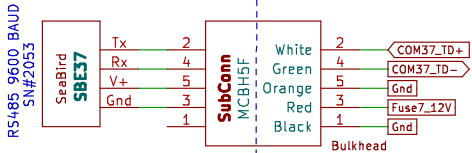
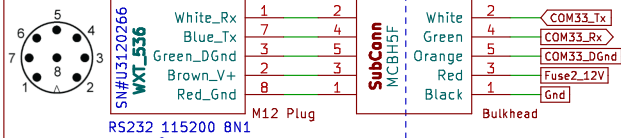
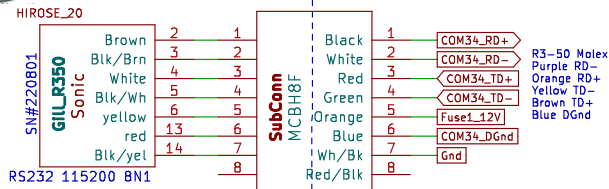

Benjamin Greenwood
Upper Ocean Processes Group
Sheet: /
File: NORSE_2023.kicad_sch

Title: NORSE 2023 Buoy

Size: USLetter Date: 2023-08-22
KiCad E.D.A. eeschema 6.0.9-8da3e8f707-117-ubuntu18.04.1

Rev:
Id: 1/1