

Woods Hole Oceanographic Institution



Stratus 14 Fourteenth Setting of the Stratus Ocean Reference Station

Cruise On Board RV *Cabo de Hornos* April 14 - 30, 2015 Valparaiso, Chile

by

Sebastien Bigorre,¹ Robert A. Weller,¹ Jeff Lord,¹ Nancy Galbraith,¹ Emerson Hasbrouck,¹
Sergio Pezoa,² Byron Blomquist,²

Woods Hole Oceanographic Institution
Woods Hole, MA 02543

April 2015

Technical Report

Funding was provided by the National Oceanic and Atmospheric Administration
under Grant No. NA14OAR4320158

Approved for public release; distribution unlimited.



Upper Ocean Processes Group
Woods Hole Oceanographic Institution
Woods Hole, MA 02543
UOP Technical Report 2015-02

¹ Woods Hole Oceanographic Institution, Woods Hole, MA
² ESRL, National Oceanic and Atmospheric Administration, Boulder, CO

WHOI-2015-03

**Stratus 14
Fourteenth Setting of the Stratus Ocean Reference Station
Cruise On Board RV *Cabo de Hornos*
April 14 - 30, 2015 Valparaiso, Chile**

by

Sebastien Bigorre, Robert A. Weller, Jeff Lord, Nancy Galbraith, Emerson Hasbrouck,
Sergio Pezoa, and Byron Blomquist

Woods Hole Oceanographic Institution
Woods Hole, Massachusetts 02543

April 2015

Technical Report

Funding was provided by the National Oceanic and Atmospheric Administration
under Grant No. NA14OAR4320158

Reproduction in whole or in part is permitted for any purpose of the United States
Government. This report should be cited as Woods Hole Oceanographic Institution Technical
Report, WHOI-2015-03.

Approved for public release; distribution unlimited.

Approved for Distribution:



Albert J. Plueddemann, Chair

Department of Physical Oceanography

Abstract

The Ocean Reference Station at 20°S, 85°W under the stratus clouds west of northern Chile is being maintained to provide ongoing climate-quality records of surface meteorology, air-sea fluxes of heat, freshwater, and momentum, and of upper ocean temperature, salinity, and velocity variability. The Stratus Ocean Reference Station (ORS Stratus) is supported by the National Oceanic and Atmospheric Administration's (NOAA) Climate Observation Program. It is recovered and redeployed annually, with past cruises that have come between October and January. This cruise was conducted on the Chilean research vessel *Cabo de Hornos*.

During the 2015 cruise on the *Cabo de Hornos* to the ORS Stratus site, the primary activities were the recovery of the previous (Stratus 13) WHOI surface mooring, deployment of the new Stratus 14 WHOI surface mooring, in-situ calibration of the buoy meteorological sensors by comparison with instrumentation installed on the ship and CTD casts near the moorings. Surface drifters were also launched along the track.

TABLE OF CONTENTS

Abstract	iii
Table of Contents	v-vi
List of Figures	vii-viii
List of Tables	viii-ix
I. Introduction	1
A. Timeline	1
B. Background and Purpose	5
II. Cruise preparations	6
A. Staging and Loading in Valparaiso	6
B. Buoy spin	7
III. Stratus 14 Mooring	8
A. Mooring Design	8
B. Buoy Instrumentation	10
1) ASIMET	10
2) Sea Surface Temperature	12
3) Air Temperature and Relative Humidity	12
4) Precipitation	13
5) Shortwave radiation	13
6) Longwave radiation	13
7) Barometric pressure	13
8) Wind	13
9) Subsurface Argos Transmitter	14
10) Telemetry	14
11) PCO ₂	14
12) Wave Package	14
13) Vaisala WXT520	15
C. Subsurface Instrumentation	15
1) VMCMs	15
2) RDI Acoustic Doppler Current profiler	18
3) Nortek	18
4) Aanderaa RCM 11s and SEAGUARD	18
5) SBE39 Temperature Recorder	18
6) SBE37 Microcat Conductivity and Temperature Recorder	18
7) Seabird 56	19
8) Seabird 16	19
9) Acoustic Release	19
10) Wetlabs Fluorometer	19
D. Current Meter Setup	20
E. Mooring Operations	21
1) Track during deployment of S14	21
2) Deployment	23
3) Anchor Survey	27
F. Measurements Inter-comparisons	32
1) Meteorological Instrumentation	32
2) Intercomparison results	37

IV. Stratus 13 Mooring	45
A. Mooring Recovery	45
B. Intercomparison: ship vs Stratus 13 buoy.....	46
C. Intercomparison: Stratus 14 vs Stratus 13 buoy	54
D. Data return from Stratus 13	59
1) ASIMET Instrumentation.....	59
2) Lascar EL-USB-2+.....	60
3) Nortek 2 MHz profiler.....	61
4) Aanderaa RCM11.....	62
5) RDI Workhorse ADCP.....	63
6) SBE 16.....	64
7) SBE 37.....	65
8) SBE 39.....	67
9) SBE 56.....	67
10) Aanderaa Seaguard.....	67
11) VMCM	69
12) WXT 520.....	70
13) Wetlabs Fluorometer	72
V. Ancillary Projects.....	74
A. CTD Casts.....	74
B. Drifters.....	80
Thanks and Acknowledgments	82
References	82
Appendix 1: Stratus 14 buoy spin	83
Appendix 2: Stratus 14 Instrument Setup	86
Appendix 3: Stratus 14 Mooring Log	100
Appendix 4: Stratus 13 Mooring Log	107

List of Figures

Fig No.	Page
1-1 Stratus 14 cruise itinerary.....	1
2-1 Buoy spin of Stratus 14 buoy.....	7
3-1 Representation of Stratus 9 ASIMET buoy (Stratus 14 is similar).....	8
3-2 Stratus 14 mooring diagram.....	9
3-3 Target area for Stratus 14 deployment track and bathymetry map.....	21
3-4 Proposed track for Stratus 14 deployment.....	22
3-5 Bathymetric survey from <i>Cabo de Hornos</i> near Stratus 14 deployment.....	23
3-6 Track of <i>Cabo de Hornos</i> during Stratus 14 deployment.....	28
3-7 Anchor survey results from Anchpos.....	29
3-8 Anchor survey results from Ecours.....	29
3-9 Anchor survey results from Angulate.....	30
3-10 Anchor survey results from Art Newhall’s program.....	30
3-11 Map of anchor survey results from Art Newhall’s program.....	31
3-12 ESRL meteorological tower on bow, O2 deck.....	33
3-13 ESRL radiations sensors, near starboard railing tower on O3 deck.....	33
3-14 Ship meteorological at top of mast, above wheelhouse.....	34
3-15 Ship’s speed during inter-comparison periods at Stratus.....	35
3-16 Relative wind speed on ship during inter-comparison periods at Stratus.....	36
3-17 Rain rate on ship during inter-comparison periods at Stratus.....	37
3-18 Vertical profile of air temperature during inter-comparison at Stratus 14.....	39
3-19 Time-series of air temperature during inter-comparison at Stratus 14.....	39
3-20 Vertical profile of specific humidity during inter-comparison at Stratus 14.....	40
3-21 Time-series of specific humidity during inter-comparison at Stratus 14.....	40
3-22 Vertical profile wind speed during inter-comparison at Stratus 14.....	41
3-23 Time-series of wind speed during inter-comparison at Stratus 14.....	41
3-24 Scatter plot of shortwave radiation during inter-comparison at Stratus 14.....	42
3-25 Time-series of shortwave radiation during inter-comparison at Stratus 14.....	42
3-26 Scatter plot of longwave radiation during inter-comparison at Stratus 14.....	43
3-27 Time-series of longwave radiation during inter-comparison at Stratus 14.....	43
3-28 Time-series of barometric pressure during inter-comparison at Stratus 14.....	44
3-29 SST and surface salinity during inter-comparison with CTD at Stratus 14.....	44
4-1 Vertical profile of air temperature during inter-comparison at Stratus 13.....	48
4-2 Time-series of air temperature during inter-comparison at Stratus 13.....	48
4-3 Time-series of specific humidity during inter-comparison at Stratus 13.....	49
4-4 Time-series of specific humidity during inter-comparison at Stratus 13.....	49
4-5 Vertical profile wind speed during inter-comparison at Stratus 13.....	50
4-6 Time-series of wind speed during inter-comparison at Stratus 13.....	50
4-7 Scatter plot of shortwave radiation during inter-comparison at Stratus 13.....	51
4-8 Time-series of shortwave radiation during inter-comparison at Stratus 13.....	51
4-9 Scatter plot of longwave radiation during inter-comparison at Stratus 13.....	52
4-10 Time-series of longwave radiation during inter-comparison at Stratus 13.....	52
4-11 Scatter plot of barometric pressure during inter-comparison at Stratus 13.....	53
4-12 Time-series of barometric pressure during inter-comparison at Stratus 13.....	53
4-13 SST and surface salinity during inter-comparison with CTD at Stratus 13.....	54
4-14 Inter-comparison Stratus 14 vs Stratus 13: Air temperature.....	56
4-15 Inter-comparison Stratus 14 vs Stratus 13: Relative humidity.....	56
4-16 Inter-comparison Stratus 14 vs Stratus 13: Wind speed.....	56
4-17 Inter-comparison Stratus 14 vs Stratus 13: Wind direction.....	56
4-18 Inter-comparison Stratus 14 vs Stratus 13: Shortwave radiation.....	57

4-19	Inter-comparison Stratus 14 vs Stratus 13: Longwave radiation	57
4-20	Inter-comparison Stratus 14 vs Stratus 13: Barometric pressure	57
4-21	Inter-comparison Stratus 14 vs Stratus 13: SST.....	57
4-22	Inter-comparison Stratus 14 vs Stratus 13: Surface conductivity	58
4-23	Inter-comparison Stratus 14 vs Stratus 13: Precipitation	58
4-24	Picture of Stratus 13 buoy after recovery: Shortwave radiation	58
4-25	Data return from Stratus 13 loggers: wind east and north, sst, salinity, precipitation.....	59
4-26	Data return from Stratus 13 loggers: ATMP, HRH, BPR, LWR, SWR	60
4-27	Data return from Stratus 13 from Lascar, logger 4, Sensirion: ATMP and HRH.....	61
4-28	Data return from Stratus 13 from Nortek profiler	62
4-29	Data return from Stratus 13 from Aanderaa RCM 11	63
4-30	Data return from Stratus 13 from RDI ADCP #1218.....	64
4-31	Data return from Stratus 13 from SBE 16s	65
4-32	Data return from Stratus 13 from SBE 37s: temperature	66
4-33	Data return from Stratus 13 from SBE 37s: salinity	66
4-34	Data return from Stratus 13 from Aanderaa Seaguards	69
4-35	Data return from Stratus 13 from VMCMs	70
4-36	Data return from Stratus 13 from Vaisala WXT 520: ATMP and HRH.....	71
4-37	Data return from Stratus 13 from Vaisala WXT 520: BPR and PRC	71
4-38	Data return from Stratus 13 from Vaisala WXT 520: WNDE and WNDN	72
4-39	Data return from Stratus 13 from Wetlabs Fluorometer	73
4-40	Map of chlorophyll content near ORS Stratus in April from Aqua/Modis	73
5-1	CTD cast 1 near Stratus 14.....	75
5-2	CTD cast 1 near Stratus 14: upper 250 m	76
5-3	CTD cast 1 near Stratus 14: T-S plot	77
5-4	CTD cast 2 near Stratus 13.....	78
5-5	CTD cast 2 near Stratus 13: upper 250 m	79
5-6	CTD cast 2 near Stratus 13: T-S plot	80

List of Tables

Table No.	Page	
2-1	Scientific participants onboard <i>Cabo de Hornos</i> during Stratus 14	06
3-2	Stratus 14 surface instrumentation spikes and notes	10
3-3	Stratus 14 ASIMET instrumentation.....	11
3-4	Stratus 14 Sea Surface Temperature Array	12
3-5	Set up of Stratus 14 subsurface instrumentation	16
3-6	Setup acoustic current meters and profilers for Stratus 14.....	21
3-7	Planned deployment track for Stratus 14	22
3-8	Acoustic ranges for Stratus 14 anchor survey	28
3-9	Triangulation results for Stratus 14 anchor survey	31
3-10	Instrumentation used for inter-comparison with ORS Stratus buoy	32
4-1	Stratus 13 ASIMET Logger data return.....	59
4-2	Stratus 13 EL-USB-2+ data return	60
4-3	Stratus 13 RCM 11 data return	63
4-4	Stratus 13 RDI ADCP data return	63
4-5	Stratus 13 SBE 16 data return.....	64
4-6	Stratus 13 SBE 37 data return.....	65
4-7	Stratus 13 SBE 39 data return.....	67
4-8	Stratus 13 SBE 56 data return.....	67
4-9	Stratus 13 Aanderaa Seaguard data return.....	68

4-10 Stratus 13 VMCM data return	69
4-11 Stratus 13 Vaisala WXT520 data return	70
5-1 Location and time of drifters launches during Stratus 14 cruise.....	81

I. Introduction

A. Timeline

Stratus 14 was conducted on the Chilean Navy Research Vessel AGS 61 *Cabo de Hornos*, with the intent of sailing from Valparaiso, Chile to the Stratus site and back to Valparaiso. During the cruise, the Chilean Navy required the ship to return to Valparaiso after the work at the Stratus site via a region off Antofagasta, Chile and to conduct a bathymetric survey of that region. The ship left Valparaiso, Chile on the morning of April 16, 2015 and returned to Valparaiso on the morning of April 30, 2015. The track (Figure 1-1) was set to first deploy the Stratus 14 mooring then recover the Stratus 13 mooring, and complete work at the Stratus site before returning back to Valparaiso, Chile. WHOI Upper Ocean Processes Group staff left Boston for Chile, on April 7 (first group) and April 10 (second group). An overview of the chronology of the cruise is provided below. We used Chile time during this cruise (UTC -3).

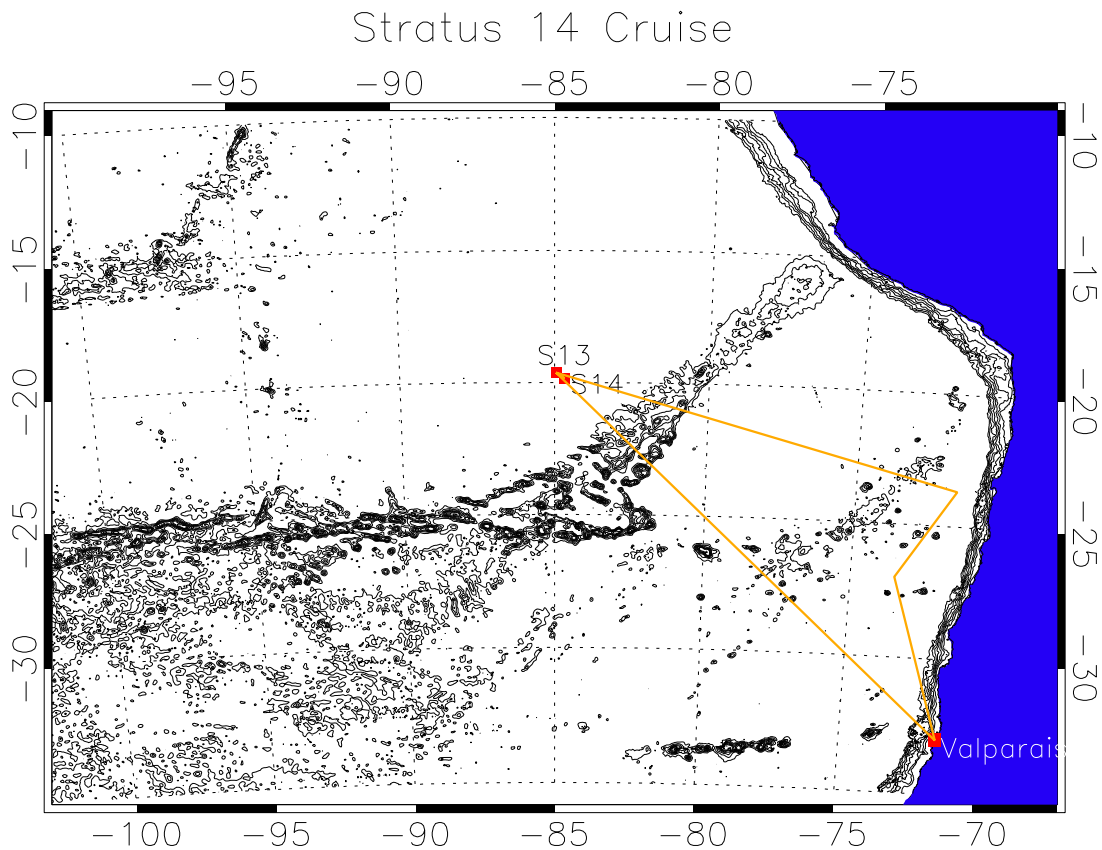

Figure 1-1. Stratus 14 cruise itinerary Valparaiso – Stratus 14 – Valparaiso, Chile.

April 7, Tuesday: First group from WHOI flies to Santiago and takes van to Valparaiso, arriving April 8.

April 8, Wednesday: Meeting with Broom agency in the afternoon.

April 9, Thursday: Meet at the First Naval District Headquarters of the Chilean Navy with Ret. Adm Ranelli of CONA (Chilean National Oceanographic Committee), Captain Fuentes of the *Cabo de Hornos*, Lt. Commander Zuñiga, and also with representatives of Broom Agency. Follow up with visit to the ship with the Captain. Agreement on the plan of having the ship sail across the harbor to the commercial pier for loading.

April 10, Friday: Lunch meeting at SHOA (Servicio Hidrografico and Oceanografico de l'Armada), briefing on and tour of SHOA. At ~15:30 local get into our containers (two 40 ft containers and one 20 foot ragtop container) on the dock.

April 11, Saturday: Buoy assembled on dock. Second UOP group arrived in Valparaiso. Argo running.

April 12, Sunday: Buoy assembly and instrument preparation continue on dock. Buoy data checked using telemetry.

April 13, Monday: Work on the dock, pack up, at the end of the day move the buoy and the containers to the location on the commercial pier (port center) where the ship will move for loading next day.

April 14, Tuesday: *Cabo de Hornos* pulls in dock at 0800. Loaded 20 ft ragtop container, equipment, anchor and buoy on ship. When finished loading, ship sails across the harbor back to the Navy dock

April 15, Wednesday: Finish preparations. Labs setup. GPS and Alpha Omega antennae installed. Aanderaa DCPII firmware upgraded for correction of pitch and roll with sensor in downward orientation.

April 16, Thursday: On board by 07:00 (local time). 09:00 underway from Valparaiso to Stratus site. Welcome briefing and introduction meeting with XO at 10:30 am. 15:00 operations briefing on the bridge. Ship stops a couple times during the day due to problems with power generator. Sailing NW at 12 kn. setting up SBE 19 for CTD. Setting up ship's ADCP and started data collection with VmDAS but there is no velocity output.

April 17, Friday: Ship stops in international waters around 10:00 for CTD and acoustic release test, but problem with CTD winch prevents operation. Ship resumes sailing and stops again, CTD in the water by 13:30.

April 18, Saturday: Underway to Stratus site. Finished setup of Seaguard DCPII. Sensirion data pulled out; no data between April 14 and 18. Reinstall as standalone for further check. Buoy data dump.

April 19, Sunday: Underway to Stratus site, loosing engine power at times. Drifter deployments start in international waters. Passed San Felix island. Deck arrangement. Sonic on ESRL mast damaged by bird; new sensor installed. Starting preparation of Stratus 14 instruments (cages and load bars installed, anti-fouling). Calm sea.

April 20, Monday: Fantail preparations finalized. Buoy tipped aft. Arrive at Stratus 13 around 1440 UTC. A half dozen of sea birds sighted near or on buoy. No damage noticed. Buoy is NW of its anchor. Ship on dynamic positioning to estimate currents (ship ADCP is not giving any current estimates) for set and drift test at Stratus 14 initial point for deployment; current from the southeast and wind from the west. Ship takes a sound velocity profile and starts a bathymetry survey with multibeam. TSG turned on around 2000 UTC. TSG stopped a few hours later because of problem with pump.

April 21, Tuesday: Deploy Stratus 14, starting on deck at about 08:30 local and 10 nm NW of anchor target position. Move about 6 nm along track during deployment. The site verifies as having good depth, so anchor drop at 19:58 UTC. Anchor survey. Then hold station near Stratus 14. Rain in mid-morning and again in evening.

April 22, Wednesday: On station in front of Stratus 14 buoy. CTD cast to 1,500 m at 13:00 UTC. Drive by to Stratus 14 buoy to check waterline around 15:00 UTC. Leave area for Stratus 13 at 20:00 UTC to check communications with S13 releases. Cloudy most day, with thick cumulus clouds and rain patches.

April 23, Thursday: On station at Stratus 13 buoy for ship-buoy comparison. Ship maneuver during the night around buoy despite instructions to stay on station, so ship's measurements are not always optimal. CTD at 13:00 UTC, with UOP and ship CTD. Small boat ride to buoy at 17:00 UTC for inspection and attach pick up line to Stratus 13 buoy for recovery next day. From 22:00 to 23:00 UTC, the ship sails at elevated speed away from Stratus 13 buoy for maintenance of engines. Sunny with patchy clouds, calm winds, swell.

April 24, Friday: Recovery of Stratus 13. Around 20:00 UTC, get underway and leave WHOI Stratus area. Launch drifters.

April 25, Saturday: Sailing east-southeast towards Antofagasta for bathymetry survey for Chilean navy. Ship does 360 degrees maneuvers en route to reduce offset between gyro and inertial motion units. Cleaning instruments.

April 26, Sunday: Sailing ESE, 11 knots. Data download from Stratus 13 subsurface instrumentation.

April 27, Monday: Sailing ESE, 11 knots. Data download from Stratus 13 meteorological instrumentation. Data download from Stratus 13 surface instrumentation. Mooring wire rewinded on spools. Bathymetry survey near Antofagasta. One crew transferred to Navy patrol boat for family matters in Chile.

April 28, Tuesday: Data download continues (VMCMs). Packing container with wire reels, air tuggers, lab equipment. Sailing southward at 11 kn. Cloudy and foggy, colder air temperature.

April 29, Wednesday: Sailing southward along coast towards Valparaiso. Packing, cruise report writing and data processing continue.

April 30, Thursday: Ship arrives in Valparaiso around 0800 UTC and anchor outside port. Ship tied up to commercial pier #5 at 11:30 UTC. Unloading of scientific equipment from ship. *Cabo de Hornos* leaves for Navy pier. Loading of scientific equipment into container until 1700 UTC.

May 1, Friday: Finalize shipment.

May 2-3, Saturday-Sunday: Travel home.

B. Background and Purpose

The presence of a persistent stratus deck in the subtropical eastern Pacific is the subject of active research in atmospheric and oceanographic science. Its origin and maintenance are still open to discussion. A better understanding of the processes responsible for this system is desirable not only because better understanding of the nature of air-sea interactions in this region is needed, but also because climate models presently have SST fields that are too warm in the eastern South Pacific. There is also the need to collect in-situ data to provide ground truth for remote sensing.

The Ocean Reference Station (ORS) at 20°S, 85°W under the stratus clouds west of northern Chile is being maintained to provide ongoing, climate-quality records of surface meteorology, of air-sea fluxes of heat, freshwater, and momentum, and of upper ocean temperature, salinity, and velocity variability. The Stratus Ocean Reference Station (ORS Stratus) is supported by the National Oceanic and Atmospheric Administration's (NOAA) Climate Observation Program. It has been recovered and redeployed annually, with cruises that have come between October and May. The Stratus 13 mooring was deployed in May 2014. Its replacement, Stratus 14 mooring, was installed on April 21 2015 during the Stratus 15 cruise, which is detailed in this report.

During the 2015 Stratus cruise on the Chilean research ship *Cabo de Hornos*, the primary activities were recovery of the WHOI Stratus 13 surface mooring, deployment of the new WHOI Stratus 14 surface mooring at a nearby site. At the Stratus mooring, in-situ calibration of the buoy meteorological sensors was done through comparison with ESRL meteorological sensors mounted on the ship and a Vaisala weather station that is part of the ship's monitoring system. CTD casts were also done near the new mooring for comparison with newly deployed instruments. Finally, surface drifters were launched during the cruise.

The ORS Stratus buoys are equipped with two Improved Meteorological (IMET) systems, which provide surface wind speed and direction, air temperature, relative humidity, barometric pressure, incoming shortwave radiation, incoming longwave radiation, precipitation rate, and sea surface temperature and salinity. The buoy is outfitted with a PCO₂ sampling system from Chris Sabine (NOAA Pacific Marine Environmental Laboratory, PMEL). It also contains a wave-measuring package designed by NDBC. The IMET data are made available in near real time using satellite telemetry. The mooring line carries instruments to measure ocean salinity, dissolved oxygen, temperature, and currents.

The Stratus 14 buoy was assembled and tested after shipping and final preparations to its moored instrumentation were carried out. Equipment for the Stratus 14 was therefore loaded onto the *Cabo de Hornos* in Valparaiso on April 15, 2015 and pre-deployment preparation was completed on board the ship in port in Valparaiso. The cruise ended in Valparaiso, where the Stratus gear was unloaded and the science party returned home.

II. Cruise Preparations

A. Staging and Loading in Valparaiso

Five weeks prior to the STRATUS 14 cruise; two forty-foot containers, and one 20-foot container, loaded with the buoy, mooring components and cruise support gear, were shipped to Valparaiso, Chile. Arrangements were made with Broom Chile, our agent in Valparaiso, to accept the equipment and provide support for WHOI. This support included a staging area, forklift support, shore crane, and port access.

Four WHOI personnel traveled to Valparaiso on April 7, arriving in the afternoon of April 8. On the afternoon of April 8, WHOI personnel met with the port agent (Broom) and began preparations for the cruise. A decision was made to postpone delivery of containers until after a meeting with the officers of the *Cabo de Hornos* on the morning of April 9. At that meeting, the *Cabo de Hornos* staff agreed to move the ship to the commercial pier for cargo loading on April 14. The containers were delivered to a staging area at 3:30 pm on April 10, and a forklift was available to assist with the unloading of containers. The buoy tower top and hull were assembled with the forklift. The anchor modules were also assembled using the forklift. Some equipment was shuffled back into the containers. One container was set up with tables and chairs to serve as a lab space for preparations. Additional WHOI personnel arrived on 11 April. Buoy assembly and test, and equipment preparation continued until the afternoon of April 13 when the gear was moved to commercial pier # 7 where it was staged for loading on April 14. At 0830 on April 14, the *Cabo de Hornos* moved from the navy pier to pier 7. A forklift and shore crane were available to assist with the loading of WHOI equipment and buoy, as well as the 20-ft ragtop container, which was secured on port side on the ship's back deck. ESRL's equipment had been loaded onboard the ship a few days prior using the ship's crane on the bow deck.

April 14-15 were used to get the labs organized and the deck set up and lashed. Cruise personnel setup the local Argos receiver and GPS stations, and the ESRL meteorological tower was raised on the bow. The *Cabo de Hornos* left Valparaiso at 09:00 local on April 16, with 6 scientists onboard (see Table 2-1) and 51 crewmembers from the Chilean Navy.

Table 2-1. Scientific participants onboard *Cabo de Hornos* during Stratus 14. cruise.

	Name	Institution	Position
1	Dr. Robert Weller	WHOI	Chief Scientist
2	Mr. Jeff Lord	WHOI	Group Ops Leader
3	Mr. Sebastien Bigorre	WHOI	Research Associate
5	Ms. Nancy Galbraith	WHOI	Information Systems
6	Mr. Emerson Hasbrouck	WHOI	Engineer Assistant
7	Mr. Sergio Pezoa	ESRL	NOAA

B. Buoy spin

The buoy spin was conducted in Woods Hole on January 23 2015. The buoy spin is a procedure to check the compasses in the wind sensors mounted on the buoy. A visual reference direction is first set using an external compass. The buoy is then oriented successively at 8 different angles with respect to the reference and the vanes of the anemometers are visually oriented and blocked towards the reference direction. Data from the wind sensor is recorded for 15 minutes at the end of which the average compass and wind direction is read. Their sum should correspond to the reference heading, within errors due to approximations in orientation, compass precision, and any deformation of the magnetic field due to the buoy metallic structure or the environment. Buoy spin results are shown in Figure 2-1, where compass error is plotted as a function of buoy orientation and the sinusoidal curve is symptomatic of the buoy spin procedure. Compasses on ASIMET wind sensors and Vaisala WXT meet expectations. See Appendix 1 for the details of the buoy spin.

Figure 2.1. Buoy spin of Stratus 14 buoy, in Woods Hole on January 23 2015.

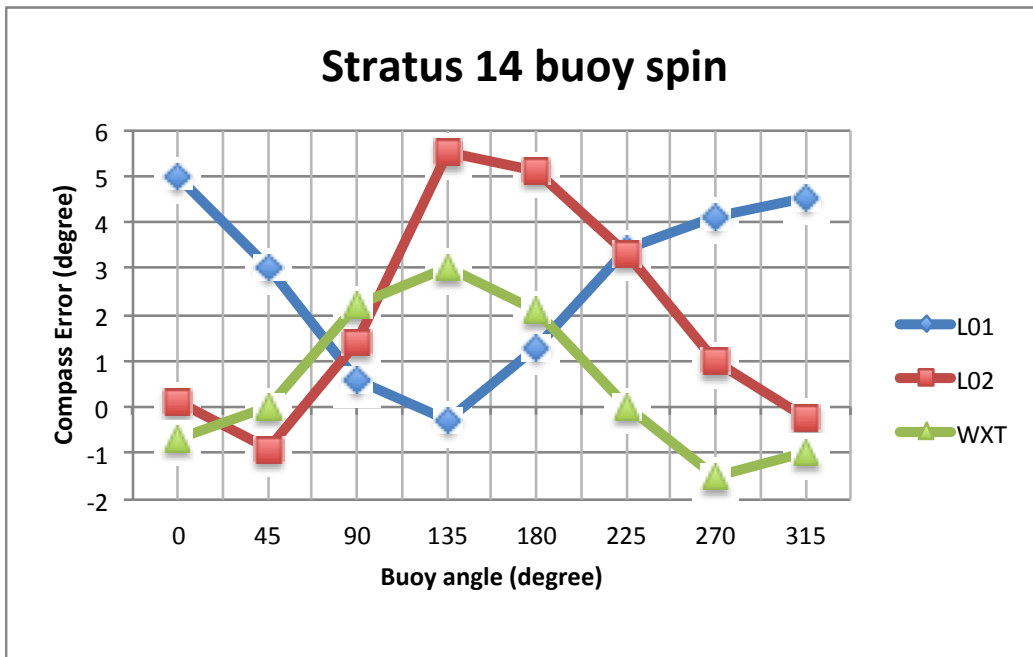

III. Stratus 14 Mooring

A. Mooring Design

The buoys used in the Stratus project are equipped with surface meteorological instrumentation, including two Improved Meteorological (IMET) systems (see Figure 3-1). The mooring line also carries subsurface instrumentation that measures conductivity and temperature and a selection of acoustic current meters and profilers and vector measuring current meters (VMCM).

The WHOI mooring is an inverse catenary design utilizing wire rope, chain, nylon and polypropylene line and has a scope of 1.25 (scope is defined as slack length/water depth). The Stratus 14 surface buoy has a 2.7-meter diameter foam buoy with an aluminum tower and rigid bridle. The design of these surface moorings takes into consideration the predicted currents, winds, and sea-state conditions expected during the deployment duration. See Figure 3-2 for the full mooring drawing.

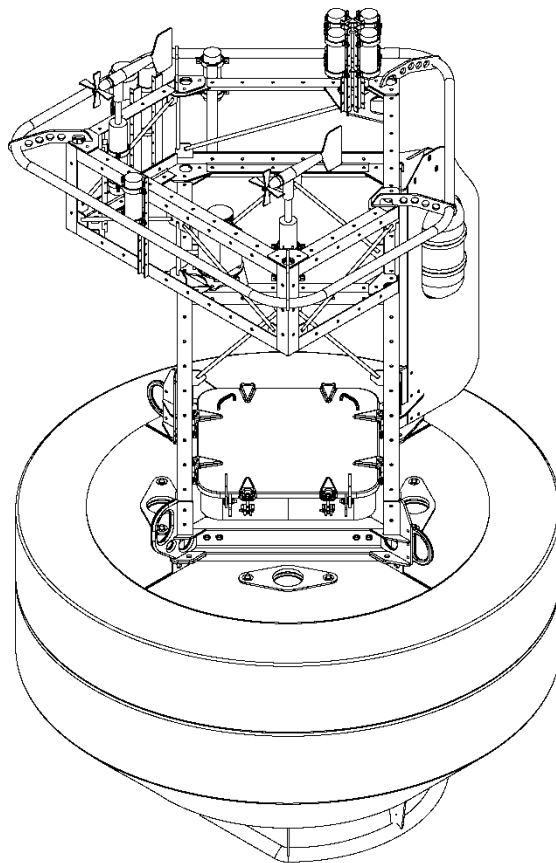
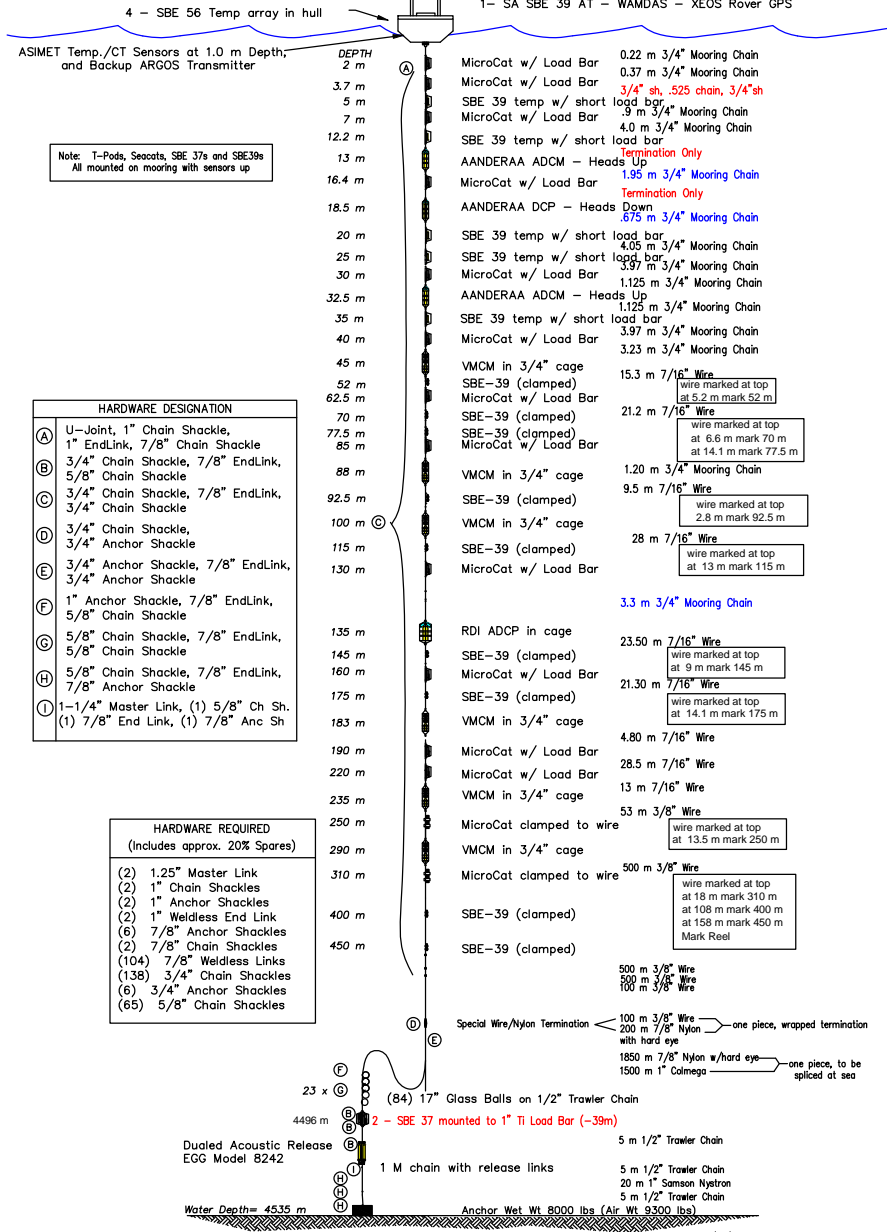

Figure 3-1: Representation of Stratus 9 ASIMET buoy (Stratus 14 is similar, although with a larger wind vane).

PO Mooring Number 1277

MAX. DIA. BUOY WATCH CIRCLE = 3.7 N.Miles
Anchor Pos. 19 56.31S, 17.56 W

2.7 m Surlyn Foam MOBS Buoy with:
(2) IMET/ARGOS Telemetry, 1- Vaisala WXT
1- Sonic Wind 1- RM Young Wind
1- Stand Alone Wind - 1 SA HRH -1 Lascar HRH
1- SA SBE 39 AT - WAMDAS - KEOS Rover GPS



STRATUS-14 MOORING V7-02/04/2015

Figure 3-2. Stratus 14 mooring diagram, as deployed.

B. Buoy Instrumentation

The Air-Sea Interaction Meteorology (ASIMET) system is a suite of meteorological surface sensors that measure air temperature (ATMP), relative humidity (HRH), sea surface temperature and conductivity (SST, SSC), wind speed and direction (WSPD, WDIR), barometric pressure (BPR), shortwave and longwave radiation (SWR, LWR), and precipitation (PRC). These variables are used to compute air-sea fluxes of heat, moisture and momentum using bulk aerodynamic formulas, (*e.g.* COARE algorithm). On buoys, ASIMET modules (one or more sensors plus front-end electronics) may be self-powered and self-logging, connected to a central power supply and logger, or both. Modules are housed in titanium cylinders and typically deployed in pairs, with meteorological modules mounted on the buoy tower and a pair of temperature-conductivity sensors attached to the bridle leg. A central logger records 1-minute data from all the modules on a common time base, and creates hourly averaged data that are transmitted to shore via Argos satellite telemetry. Some of the 1-minute data are averages within each minute (see ASIMET documentation on <http://frodo.who.edu/asimet>). The Stratus mooring also includes a pCO₂ system from Dr. Chris Sabine of NOAA PMEL and an NDBC wave sensor package.

1) ASIMET

Table 3-1 lists the time of the spikes (ice bath) imposed in the ASIMET data records before deployment on Stratus 14, while Table 3-2 contains the list of ASIMET sensors deployed.

Table 3-1: Stratus 14 surface instrumentation spikes and notes.

Logger 1 (L-01): start 4/11/2015 14:05:30
All modules start 4/11/2015 14:02:00, except SST start 4/11/2015 20:00:00
SWR 216, LWR 219 cover/uncover 4/19/2015 18:35-19:10
PRC 504: 150 ml 4/19/2015 17:39. Fill/drain 4/19/2015 18:33
SST 1839: In seawater 4/11/2015 19:19. Cold temp spike 4/13/2015 13:27-13:45.
Logger 2 (L-02): start 4/11/2015 14:56:30
All modules start 4/11/2015 14:43:00, except SST start 4/11/2015 20:00:00
SWR 215, LWR 503 cover/uncover 4/19/2015 18:35-19:10
PRC 218: 150 ml 4/19/2015 17:39. Fill/drain 4/19/2015 18:33
SST 1725: In seawater 4/11/2015 19:19. Cold temp spike 4/13/2015 13:27-13:45.
HRH 233 Sensirion: Start 4/11/2015 17:35:00
SBE 39 5275: Start 4/17/2015 22:00:00
VWX 8: Card erased 4/14/2015 14:39.
Lascar 10023643: Start 4/12/2015 15:00:00
SWR K&Z 801: Start 4/11/2015 17:42:30. Spike 4/19/2015 18:35-19:10.

Table 3-2. Stratus 14 ASIMET instrumentation on buoy (heights are referenced to buoy deck, which is 60 cm above waterline)

System 1			
Module	Serial	Firmware Version	Height (cm)
Logger Starboard	L-01	v4.11cf	
HRH	503	VOSHRH53 v4.43cf	235
BPR	234	VOSBPR53 v4.03cf (Heise)	238
WND	344	VOSWND53 v4.02cf	269
PRC	504	VOSPRC53 v4.03cf	247
LWR	219	VOSLWR53 v4.02cf	284
SWR	216	VOSSWR53 v4.01cf	284
SST	1839	v2.3b	n/a
PTT	99538	14644, 14652, 14653	n/a
System 2			
Module	Serial	Firmware Version	Height (cm)
Logger Port	L-02	LOGR53 v4.11cf	
HRH	250	VOSHRH53 v4.29cf	235
BPR	213	VOSBPR53 v4.03cf (heise)	238
WND	205	VOSWND53 v4.02cf	269
PRC	218	VOSPRC53 v4.03cf	247
LWR	503	VOSLWR v4.02cf	284
SWR	215	VOSSWR53 v4.01cf	284
SST SBE37	1725	v2.3b	n/a
PTT	14709	09805, 09807, 09811	n/a
Stand-Alone Modules			
Module	Serial		Height (cm)
HRH (sensirion)	233	VOSHRH53 v4.29cf	240
SBE-39-AT	5275	3.1b	228
KZ-SWR	801	VOSSWR53 v4.01cf	284
Lascar AT/RH	10023643	v1.1	224
VWX	008	VOSWXT520 v4.04cf	252
PCO2 (air block)			
SAMI			
SBE16 (PMEL)			
Kilo Beacon		IMEI# 300234062943610.00	
XEOS Rover beacon		IMEI# 300434060447400	
NDBC Station 32012 Wave package			
WAMDAS s/n: 4003 v1.40. 3DM-GX1			
Irridium modem IMEI: 300124000115920. SIM: 89881 69312 00205 1336			
Magnetic variation = 6.86 degrees East			

2) Sea Surface Temperature

Two Sea-Bird SBE 37s are mounted to the bottom of the buoy hull at approximately 1-meter depth. These instruments are part of the ASIMET system and provide data of temperature and conductivity near the sea surface from one single measurement each minute. Hourly averages are also transmitted through Argos in near real time. The full 1-minute data are transmitted to the logger whereas the internal memory of the SBE 37 records only 5-minute data. In addition to these SST sensors, an array of Seabird 56 sensors was placed in holes in the buoy foam hull. Table 3-3 lists the SST instrument array on the buoy hull.

Table 3-3: Stratus 14 Sea Surface Temperature Array. Orientation is in degrees, positive clockwise, with buoy vane=0 (AFT) and buoy front =180 (FORWARD).

Instrument	Serial	Depth Below Deck (cm)	Orientation Degrees
SBE56	1208	90	PORT 90
SBE56	1210	90	FORWARD 180
SBE56	1211	120	FORWARD 180
SBE56	2069	140	FORWARD 180
SBE56	1206	90	STARBOARD 225

3) Air Temperature and Relative Humidity

The Rotronic MP-101A sensor has 1%RH, 0.05°C accuracy after UOP lab calibration. Drift (post vs. pre calibration after one year): 1%RH, 0.05°C (Colbo and Weller, 2009). The sensor probe is protected by a Rotronic MF25 membrane filter and placed inside a modified R.M. Young multi-plate radiation shield for standard use. Sensors are installed opposite to the buoy vane to provide unobstructed airflow and minimize heat-island effects. Measurement is formed from one single snapshot each minute. There are indications from recent deployments during the past two years that the Rotronic sensors can drift from their calibration after shipping and lead to unacceptable biases. An additional air temperature is therefore installed on Stratus 13 and 14 and consists of a Seabird SBE 39 with solar shield, sampling air temperature once every 5 minutes.

A new Sensirion HRH sensor was also deployed as a standalone unit on the Stratus 14 buoy to test its performance. Although it was initially planned to be a primary sensor linked to one of the loggers, suspicions that it caused problems with Argos transmissions from that logger lead to its becoming a standalone. According to the manufacturer, resolution for HRH and ATMP are 1.8 %RH and 0.3 °C, while accuracies are 0.05%RH and 0.01 °C. The datasheet also claims drifts less than 0.5%RH and 0.04 °C but mentions these could be higher due to environmental conditions like high concentrations of volatile organic compounds. The SHT75 contains a capacitive sensor element for measuring relative humidity while a band-gap sensor measures temperature. For more information, see Sensirion website: <http://www.sensirion.com/en/products/humidity-temperature/humidity-sensor-sht75/>.

4) Precipitation

RM Young 50202 Self-siphoning rain gauge. Accuracy of rain rate after lab calibration, 1 mm / hr (Serra et al., 2001). Measurement is formed from one single snapshot each minute.

5) Shortwave radiation

Eppley Precision Spectral Pyranometer (PSP). Accuracy from comparison to standard, 2 W/m² (Colbo and Weller, 2009). Drift (post vs. pre calibration after one year): 2 W/m² (Colbo & Weller, 2009). Radiation sensors are mounted higher than other instruments on buoy to avoid shadowing. 1-minute sample is formed by averaging over 6 snapshot measurements taken 10 seconds apart. This year, a Kipp and Zonen sensor was also used as a standalone.

6) Longwave radiation

Eppley Precision Infrared Radiometer (PIR). Accuracy from comparison to standard, 2 W/m² (Colbo and Weller, 2009). Drift (post vs. pre calibration after one year): 2 W/m² (Colbo and Weller, 2009). Measurement is formed from one single snapshot each minute.

7) Barometric pressure

Heise DXD (Dresser Instruments). Accuracy after UOP lab calibration, 0.2 mb. Drift (post vs. pre calibration after one year): 1.5 mb (Colbo and Weller, 2009). Measurement is formed from one single snapshot each minute.

8) Wind

R.M. Young 5103 wind monitor. Accuracy after UOP lab calibration, 1%, 3 degrees. Drift (post vs. pre calibration after one year): 0.1 m/s, 2.0 deg (Colbo and Weller 2009). Sensor is mounted opposite to the buoy vane to minimize flow disturbance. Velocity speed is measured from propeller rotations over 5 seconds, one vane measurement each second, and a single snapshot of compass during these 5 seconds. For each 5 seconds segment, a vector average is formed from the 5 seconds average vane and single snapshot compass. Eleven of these 5 seconds velocity vectors are averaged at the end of the minute interval to form the final velocity output. A scalar average of wind speed is also computed from the rotations of the propellers, but this measurement is noisier and recorded on the memory card with less resolution.

A Gill Sonic Wind Sensor was incorporated on the recovered Stratus 13 buoy. The anemometer measures the time taken for an ultrasonic pulse to travel from one transducer to the opposite transducer and then compares it with the time taken for another pulse to travel in the opposite direction. Likewise, differences are measured between other pairs of transducers allowing calculations of both wind speed and direction. This sensor samples at 40 Hz and the 1-minute data is formed from eleven 5-seconds averages, similar to the RM Young wind processing.

9) Subsurface Argos Transmitter

A subsurface beacon built by XEOS was mounted upside down on the bottom of the buoy. This is a backup recovery aid in the event that the mooring parts from its anchor and the buoy capsizes.

10) Telemetry

Each ASIMET module onboard the buoy samples data every minute and records it on a dedicated flashcard. The logger receives and stores this data. It also computes hourly averages for Argos transmissions. These Argos transmissions can be picked up as well by an Alpha Omega Uplink receiver directly from the Argos antenna on the buoy. The hourly averages help to monitor the status of instruments and the quality of data they provide.

11) PCO₂

Upwelling in the equatorial Pacific leads to enhanced productivity and degassing of CO₂ across a region ranging from the coast of South America to past the International Date Line. The vast area affected makes this region a significant contributor to global biogeochemical cycles. Variability in the South American upwelling region has been linked to a wide range of ecosystem and biogeochemical changes. Understanding this variability is a primary reason for the ongoing work at the Stratus site. The PCO₂ system on the Stratus mooring is a component of the OceanSITES moored PCO₂ network.

CO₂ measurements are made every three hours in marine boundary layer air and air equilibrated with surface seawater using an infrared detector. The detector is calibrated prior to each reading using a zero gas derived by chemically stripping CO₂ from a closed loop of air and a span gas (414 ppm CO₂) produced and calibrated by NOAA's Earth System Research Laboratory (ESRL).

A summary file of the measurements is transmitted once per day and plots of the data are posted in near real-time to the web. To view the daily data, visit the NOAA PMEL Moored CO₂ Website: <http://www.pmel.noaa.gov/co2/story/Stratus>. Within a year of system recovery, the final processed data are submitted to the Carbon Dioxide Information Analysis Center (CDIAC) for release to the public.

12) Wave Package

The WAMDAS wave system used on the Stratus 13 and 14 buoys is made by Neptune Sciences and acquired from NDBC. This includes wave measurements, GPS position and time. It utilizes a 3-axis motion package made by MicroStrain Inc. The WAMDAS is capable of transmitting and storing data. The transmitted data is sent via Iridium communications on an hourly basis. This message is ultimately transmitted to NDBC where the data are subjected to automated quality-control checks and then posted on the NDBC web site. The data are stored in raw and processed format on a 1 GB compact flash card in the instrument.

13) Vaisala WXT520

The Vaisala Weather Transmitter WXT520 measures barometric pressure, humidity, precipitation, temperature, and wind speed and direction. It uses ultrasound to determine horizontal wind speed and direction. Barometric pressure, temperature, and humidity measurements are combined in the PTU module using capacitive measurement for each parameter. The WXT520 also measures accumulated rainfall, rain intensity and duration of the rain, all in real time. The signals exerting from the impacts are proportional to the volume of the raindrops. Hence, the signal from each drop can be converted directly to the accumulated rainfall. According to manufacturer, accuracies are 0.3 m/s or 3% for wind speed, 3° for wind direction, 0.3°C for air temperature, 3%RH below 90%RH (in practice we find this sensor to have a low HRH bias larger than this value when compared to ASIMET sensors), 0.1 mbar for barometric pressure, 5% for rain accumulation (not including wind effects).

C. Subsurface Instrumentation

The following sections describe individual instruments on the buoy bridle and mooring line. Where possible, instruments were protected from being fouled by fishing lines using “trawl-guards” designed and fabricated at WHOI. These guards are meant to keep lines from hanging up on the in-line instruments.

Before a buoy launch and after its recovery, different physical signals are imprinted in the instruments’ records at determined times. These spikes reveal the possible presence of a drift in the internal clock of instruments. Temperature and salinity sensors are plunged into a large bucket filled with ice and fresh water for about an hour. VMCM rotors are spun and then blocked.

Table 3-4 summarizes the subsurface instrumentation set up. The details of the set up are shown in Appendix 2. Mooring logs are in Appendixes 3 and 4 and contain descriptions of deployment and mooring instrumentation for Stratus 14 and 13.

1) VMCMs

The VMCM has two orthogonal cosine response propeller sensors that measure the components of horizontal current velocity parallel to the axles of the two-propeller sensors. The orientation of the instrument relative to magnetic north is determined by a flux gate compass. East and north components of velocity are computed continuously, averaged and then stored. All the VMCMs deployed from Stratus 4 onward have been next generation models that have newer circuit boards and record on flash memory cards instead of cassette tape. Temperature was also recorded using a thermistor mounted in a fast response pod, which was mounted on the top end cap of the VMCM.

Table 3-4. Set up of Stratus 14 subsurface instrumentation. Spikes for VMCMs correspond to times when elastic bands were removed from rotors, which then started to spin from airflow or manual action.

Instrument	Serial	Depth (m)	Sample	Start Date & Time	Spike Start	Spike Stop
AANDERA ADCM	235	32.5	30	2015/4/1 0100	2015/4/14 13:55	2015/4/14 15:15
AANDERA ADCM	238	13	30	2015/4/1 0100	2015/4/14 18:15	2015/4/15 11:05
AANDERA ADCP	1500	18.5	60	2015/4/18 2300	2015/4/19 14:43	2015/4/19 16:30
MicroCat	1304	2	5	2015/4/1 0100	2015/4/13 14:30	2015/4/13 16:35
MicroCat	3821	3.7	5	2015/4/1 0100	2015/4/13 14:30	2015/4/13 16:35
MicroCat	3824	7	5	2015/4/1 0100	2015/4/13 14:30	2015/4/13 16:35
MicroCat	1899	16.4	5	2015/4/1 0100	2015/4/13 14:30	2015/4/13 16:35
MicroCat	1900	30	5	2015/4/1 0100	2015/4/13 16:45	2015/4/13 17:27
MicroCat	1901	40	5	2015/4/1 0100	2015/4/13 16:45	2015/4/13 17:27
MicroCat	1902	62.5	5	2015/4/1 0100	2015/4/13 16:45	2015/4/13 17:27
MicroCat	8004	85	5	2015/4/13 1200	2015/4/13 16:45	2015/4/13 17:27
MicroCat	1903	130	5	2015/4/1 0100	2015/4/13 17:50	2015/4/13 18:25
MicroCat	1905	160	5	2015/4/1 0100	2015/4/13 17:50	2015/4/13 18:25
MicroCat	1907	190	5	2015/4/1 0100	2015/4/13 17:35	2015/4/13 17:47
MicroCat	2011	220	5	2015/4/1 0100	2015/4/13 17:35	2015/4/13 17:47
MicroCat	10	250	5	2015/4/13 1200	2015/4/13 17:50	2015/4/13 18:25
MicroCat	7836	310	5	2015/4/13 1200	2015/4/13 17:50	2015/4/13 18:25
MicroCat	10600	4496	5	2015/4/13 1200	2015/4/13 17:35	2015/4/13 17:47
MicroCat	10601	4496	5	2015/4/13 1200	2015/4/13 17:35	2015/4/13 17:47
RDI ADCP	12254	135	60	2015/4/13 1400	2015/4/19 14:43	2015/4/19 16:30

SBE 39	39	5	5	2015/4/1 0100	2015/4/13 13:46	2015/4/13 14:28
SBE 39	41	12.2	5	2015/4/1 0100	2015/4/13 13:46	2015/4/13 14:28
SBE 39	53	20	5	2015/4/1 0100	2015/4/13 13:46	2015/4/13 14:28
SBE 39	101	25	5	2015/4/1 0100	2015/4/13 13:46	2015/4/13 14:28
SBE 39	721	35	5	2015/4/12 1800	2015/4/13 13:46	2015/4/13 14:28
SBE 39	1502	52	5	2015/4/1 0100	2015/4/13 13:46	2015/4/13 14:28
SBE 39	1509	70	5	2015/4/1 0100	2015/4/13 13:46	2015/4/13 14:28
SBE 39	1511	77.5	5	2015/4/1 0100	2015/4/13 13:46	2015/4/13 14:28
SBE 39	3423	92.5	5	2015/4/1 0100	2015/4/13 13:46	2015/4/13 14:28
SBE 39	3434	115	5	2015/4/1 0100	2015/4/13 13:46	2015/4/13 14:28
SBE 39	3435	145	5	2015/4/1 0100	2015/4/13 13:46	2015/4/13 14:28
SBE 39	3437	175	5	2015/4/1 0100	2015/4/13 13:46	2015/4/13 14:28
SBE 39	3438	400	5	2015/4/1 0100	2015/4/13 13:46	2015/4/13 14:28
SBE 39	3439	450	5	2015/4/1 0100	2015/4/13 13:46	2015/4/13 14:28
SBE 56	1206		1	2015/4/19 1440	2015/4/19 14:43	2015/4/19 16:30
SBE 56	1208		1	2015/4/12 2000	2015/4/13 13:33	2015/4/13 13:58
SBE 56	2069		1	2015/4/12 2000	2015/4/13 13:33	2015/4/13 13:58
SBE 56	1210		1	2015/4/1 0100	2015/4/13 13:33	2015/4/13 13:58
SBE 56	1211		1	2015/4/1 0100	2015/4/13 13:33	2015/4/13 13:58
VMCM	35	45	1	2015/4/15 16:44:37	2015/4/21 11:33	
VMCM	2058	88	1	2015/4/15 16:55:38	2015/4/21 13:04	
VMCM	2068	100	1	2015/4/15 16:56:58	2015/4/21 13:10	
VMCM	2059	183	1	2015/4/15 17:04:58	2015/4/21 13:50	
VMCM	61	235	1	2015/4/15 17:17:19	2015/4/21 14:08	
VMCM	2010	290	1	2015/4/15 17:20:03	2015/4/21 14:14	

2) RDI Acoustic Doppler Current Profiler

The RD Instruments (RDI) Workhorse Acoustic Doppler Current Profiler (ADCP, Model WHS300-1) is mounted looking upwards on the mooring line. The RDI ADCP measures a profile of current velocities. The beams have a 20° angle. Head is in the Janus configuration (4 acoustic beams to identify upstream flow).

3) Nortek

The Nortek Aquadopp current meters and profilers use Doppler technology to measure currents. The Aquadopp instruments we use on Stratus usually have three beams tilted at 25 degrees and use a transmit frequency of 1 or 2 MHz, with a higher ranging for the lower frequency signal. The internal tilt and compass sensors allow for the rotation of the current vector from beam coordinates into East, North and upward directions.

4) Aanderaa RCM 11 and SEAGUARD

The Aanderaa RCM 11 measures the horizontal current speed and direction, as well as temperature. The instrument can operate continuously or in eight intervals from 1 to 120 minutes.

The new SEAGUARD RCM series replaces the industry Standard RCM 9 and RCM 11 series. It has been completely redesigned from bottom up and employs modern technology in the data logger section and in the different sensor solutions. Some of these instruments also include an external oxygen sensor.

For Stratus 14, a new Seaguard DCP II profiler was also mounted on the mooring, looking upside down. Aanderaa loaned this instrument for beta testing. Some late updates on firmware had to be done in port in Valparaiso in order to remediate an error in rotation of tilts when sensor was orientated looking down.

5) SBE39 Temperature Recorder

The Sea-Bird model SBE39 is a small, lightweight, durable and reliable temperature logger. It is a high-accuracy temperature recorder (pressure optional) with internal battery and non-volatile memory for deployment at depths up to 10,500 meters (34,400 feet).

6) SBE37 MicroCat Conductivity and Temperature Recorder

The MicroCat, model SBE37, is a high-accuracy conductivity and temperature recorder with internal battery and memory. The temperature range is -5° to +35°C, and the conductivity range is 0 to 6 Siemens/meter. The pressure housing is made of titanium and is rated for 7,000 meters. The instruments were mounted on in-line tension bars and deployed at various depths throughout the moorings. The conductivity cell is protected from bio fouling by the placement of antifouling cylinders at each end of the conductivity cell tube.

7) Seabird56

The SBE 56 is a low-cost, high-accuracy, battery-powered temperature and time logger. Its pressure-protected thermistor has a 0.5 second time constant, providing excellent accuracy (initial accuracy 0.002 °C) and resolution when fast sampling at 2 Hz (0.5 sec). It has exceptional stability; drift is typically less than 0.002 °C per year.

8) Seabird16

The SBE 16 SEACAT is designed to measure and record temperature and conductivity in the range -5 to +35 °C at high levels of accuracy (0.01 °C) and resolution (0.001 °C) while deployed in either a fixed or moored application. Powered by internal batteries, SEACAT is capable of recording data for periods of a year or more. Data may be acquired at intervals of 15 seconds to 8 hours in one-second increments.

9) Acoustic Release

The acoustic release used on the Stratus 13 and 14 moorings are EG&G Model 8242. This release can be triggered by an acoustic signal and will release the mooring from the anchor. Releases are tested at depth prior to deployment to ensure that they are in proper working order.

10) Wetlabs Fluorometer

Stratus 13 was our first mooring to be equipped with a newly acquired fluorometer. The Environmental Characterization Optics, or ECO miniature fluorometer allows the user to measure relative chlorophyll, CDOM, uranine, phycocyanin, or phycoerythrin concentrations by directly measuring the amount of fluorescence emission in a sample volume of water. The ECO uses an LED to provide the excitation source. An interference filter is used to reject the small amount of out-of-band and scattered excitation light emitted by the LED. The light from the source enters the water volume at an angle of approximately 55–60 degrees with respect to the end face of the unit. Fluoresced light is received by a detector positioned where the acceptance angle forms a 140-degree intersection with the source beam.

Do not face the sensor directly into the sun or other bright lights. Raw data from the ECO meter is output in counts from the sensor, ranging from 0 to approximately 16000. The scale factor is factory-calculated by obtaining a consistent output of a solution with a known concentration, then subtracting the meter's dark counts. The scale factor, dark counts, and other characterization values are given on the instrument's characterization sheet. For chlorophyll, WET Labs uses the chlorophyll equivalent concentration (CEC) as the signal output using a fluorescent proxy approximately equal to 25 µg/l of a *Thalassiosira weissflogii* phytoplankton culture:

Scale Factor = 25 µg/l / (Chl Equivalent Concentration – dark counts). For example, 25 / (3198 – 71) = 0.0080. For the instrument recovered from Stratus 13, scale factor is 0.0076 and dark count is 49.

D. Current Meter Setup

The setup of current meters and profilers is a tradeoff between measurement precision and length of the record (battery life). Batteries for RDI are 1600 W.h and Seaguard's are 30 A.h For profilers, the number of cells and subsequent range is also a criterion. For details of the setup, see Table 3-5 and Appendix 2.

Note that for a profiler near the surface, by choosing cells that are higher than the water surface, it is possible to diagnose possible problems in the data because there is a lot of backscatter caused by the air-water interface. For example, if a beam does not show a maximum in the signal intensity near the surface, its record should be used with caution. Also, if the maximum in intensity appears in different cells for different beams, it indicates that the instrument (and therefore the mooring line) was probably tilted. However, the signal is valid only below and away from the surface because of the side lobe reflections (maximum distance is therefore a function of $\cos(\alpha)$, where α is the angle of the beam with the vertical).

The RDI Workhorse Sentinel (at 135 m depth) operates at 307,200 Hz, with 4 beams at 20° from the vertical. For Stratus 14 and 13 the blanking distance was set to 1.76m; 150 pings per ensemble and 1s per ping and 1hr for output sampling were selected. With EZ=1111101, ADCP will measure depth, temperature, heading, pitch, roll from its internal sensors and compute sound velocity.

Aanderaa Seaguards are current meters with beams oriented 2° from horizontal. For Stratus 14, we also mounted a new Seaguard II for beta testing. The instrument can receive two Lithium batteries (7V, 35 A.h each). In preparation for this beta testing, Harald Tholo at Aanderaa ran a few setup configurations in order to estimate the power consumption and maximum duration for sampling. In burst mode (300 pings hourly), narrowband, cell size 2 m (5 m) and 50 (20) cells, the ping rate is 2 Hz (1.7 Hz), average current is 11.2 mA (31.5 mA) and estimated duration is 260 days (93 days). Using the multicolumn feature (computes velocity in different bins for each beam) with 2 m and 5 m bins (50 and 20 cells), the ping rate is 1.08 Hz, average current is 14.7 mA and duration is 198 days. In order to sample for more than one year, it was decided to double power capability and add batteries that would be installed in an external shallow pressure case. With the multicolumn sampling, estimated duration would be 396 days. The instrument was set to sample in burst mode every hour, which means it would send 300 pings at the end of each hour. It was also set to sample in narrowband mode, which can range up 80 m.

Table 3-5. Setup of acoustic current meters and profilers for Stratus 14.

Instrument	RDI	Aanderaa SeaGuard II	Aanderaa Seaguard	Aanderaa Seaguard
Serial number	12254	1500	235	238
Sampling Freq kHz	307.2	600	1,900-2,000	1,900-2,000
Measurement Interval (s)	3600	3600	1800	1800
Number cells	12	20 (50)	1	1
Cell size (m)	8	5 (2)	2.5	2.5
Blanking distance (m)	1.76	3.5	0.5	0.5
Average Interval (pings)	150	300	300	300
Battery days		540	706	706
Depth (m)	135	18.5	32.5	13
Orientation	up	down	up	up
Beam angle (°), width	20	25 (2.5)	2	2
Comments		narrowband		

E. Mooring Operations

1) Track during Deployment of Stratus 14

In planning the S14 mooring deployment, the decision was made to make use of an area of ground with suitable bathymetry that had been found to the south-southeast of Stratus 13. This area is shown in Figure 3-3.

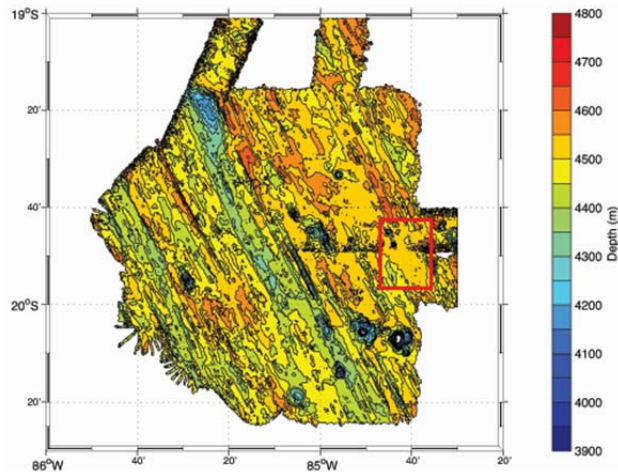

Figure 3-3. Target area for Stratus 14 deployment indicated by red rectangle.

A tentative course of steaming into the wind along a track toward 123° was planned, with a start point upwind, a target 10 nm down the track, and a further 5 nm end point target

(Table 3-6). Superimposed upon the bathymetric map from previous years, this track line is shown in Figure 3-4.

Table 3-6. Planned deployment track for Stratus 14.

	Latitude	Longitude	Distance along track
Start	19° 44.926' S	084° 40.995' W	0
Anchor target	19° 51.039' S	084° 40.995' W	10 nm
End	19° 53.983' S	084° 36.714' W	15 nm

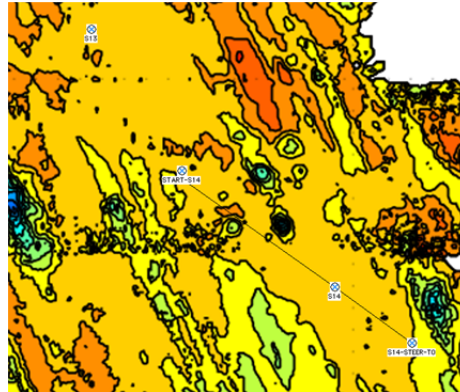

Figure 3-4. Proposed track line for Stratus 14. Note the location of the Stratus 13 anchor up to the northwest.

The day before the deployment, the ship went to the start position and assessed the wind and currents. The currents were out of the east-southeast and the wind was out of the southeast, so the proposed track was accepted.

To further support the deployment, the *Cabo de Hornos* conducted a bathymetric survey in an area including the proposed track line. A sound velocity profile was obtained to 1,500m by deploying the ship's CTD. The survey obtained by the *Cabo de Hornos* is shown in Figure 3-5.

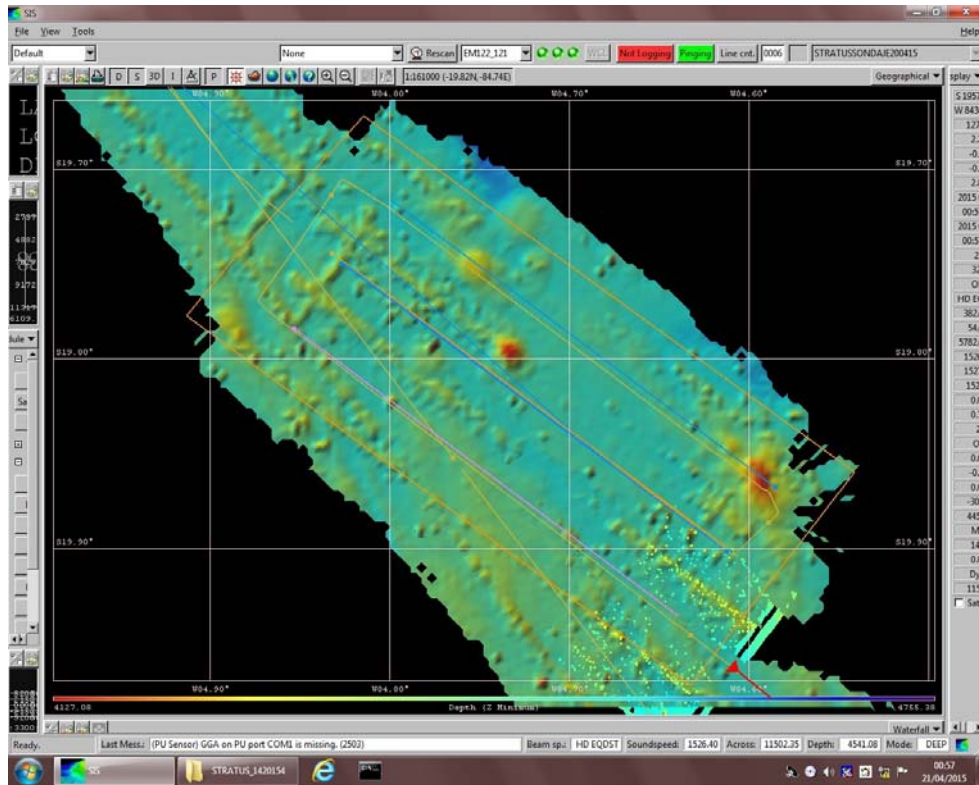

Figure 3-5. Bathymetric survey obtained by *Cabo de Hornos*. Proposed track line is dark blue in the center running northwest to southeast. Ship track is in light blue.

On April 21, the ship was in position at the start point by 08:30 local (11:30 UTC). With the ship maneuvering to support the buoy deployment and launch of the upper part of the mooring, little progress along the line was made. Then the ship started to steam toward the target, as shown in Figure 3-6. In the afternoon, the work reached the point where the anchor was attached. At that point, about 6 nm progress had been made along the line toward the target site. Using the ship's new bathymetric map and the multibeam system, the depth was checked. At that time, the ship was in water about 200 m to 300 m deeper than planned. The anchor deployment was thus delayed until a more suitable depth was found. Once it was verified that the water depth was suitable, close to 4,500 m, the work proceeded with the anchor being deployed at 19:58 UTC. As shown in the track plot, the ship pulled off to one side and sat for an hour while the anchor settled to the bottom.

2) Deployment

The Stratus 14 surface mooring was set using a two-phase mooring technique. Phase 1 involved the lowering of approximately 50 meters of instrumentation followed by the buoy, over the starboard side of the ship. Phase 2 is the deployment of the remaining mooring components through the A-frame on the stern.

The TSE winch drum was pre-wound with the following mooring components listed from deep to shallow, below. A tension cart was used to pre-tension the nylon and wire during the winding process:

- 200 m 7/8" nylon – 100 m 3/8" wire rope (nylon to wire shot)
- 100 m 3/8" wire
- 500 m 3/8" wire
- 500 m 3/8" wire
- 500 m 3/8" wire
- 53 m 3/8" wire
- 50 m 3/4" spectra working line

Prior to the deployment of the mooring, the working line was passed out through the center of the A-frame, around the aft starboard quarter then forward along the rail to the instrument lowering area.

Three wire handlers were stationed around the aft starboard rail and A-frame. The wire handlers' job was to keep the working line from fouling in the ship's propellers and to pass the line around the stern after the buoy was deployed.

To begin the mooring deployment, the ship hove to with the bow positioned with the wind slightly on the starboard bow. The crane boom was positioned over the instrument lowering area to allow a vertical lift of at least four meters. All subsurface instruments for this phase had been staged on the deck, in order of deployment, just forward of the buoy. All instrumentation had chain shackled to the top of the instrument load bar or cage. A shackle and ring was attached to the top of each shot of chain or wire.

The first instrument segment to be lowered was a VMCM current meter at 45m. This instrument had a 3.23-meter shot of chain shackled to the top of the instrument cage, and a 15.3-meter shot of 7/16" wire rope shackled to the bottom. This segment of wire was shackled into the working line coming from the winch. The crane hook, suspended over the instrument lowering area was lowered to approximately 1 meter off the deck. A six-foot sling was hooked onto the crane and passed through a ring to the top of the 3.66-meter shot of chain shackled to the top of the current meter.

The crane was raised so the chain and instrument were lifted off the deck. The crane slowly lowered the wire and attached mooring components into the water. The line handlers positioned around the stern and eased the line over the starboard side, paying out enough to keep the mooring segment vertical in the water. A sling with a snap hook was secured to a deck cleat to stop the vertical mooring line and remove it from the crane. Lowering continued with 12 more instruments and chain segments being picked up and placed over the side.

The operation of lowering the upper mooring components was repeated up to the 5-meter SBE 39 temperature logger. The load from this instrument array was stopped off using a slip line passed through a pear link shackled into the chain above the load bar. The 2-

meter and 3.7-meter instruments were shackled to hardware and chain, connecting them to the universal joint on the bottom of the buoy. The vertical instrument array hanging in the water was joined to the two instruments attached to the bottom of the buoy.

The next operation was launching the buoy. Three slip lines were rigged on the buoy to maintain control during the lift. Lines were rigged on the buoy bottom, the tower, and a buoy deck bail. The 30 ft. slip line was used to stabilize the bottom of the buoy at the start of the lift. The 50 ft. tower slip line was rigged to check the tower as the hull swung outboard. A 75 ft. buoy deck bail slip line was rigged to prevent the buoy from spinning as the buoy settled in the water. This is used so the quick release hook, hanging from the crane, could be released without fouling against the tower. The deck slip line was removed just following the release of the buoy.

With the three slip lines in place, the crane was positioned over the buoy. The quick release hook, with a 1" sling link, was attached to the crane hook. Slight tension was taken up on the crane to hold the buoy. The ratchet straps securing the buoy to the deck were removed. The buoy was raised up and swung outboard as the slip lines kept the hull in check. The stopper line holding the suspended 45 meters of instrumentation was eased off to allow the buoy to take the hanging load. The lower slip line was removed first, followed by the tower slip line. Once the buoy had settled into the water and the release hook had gone slack, the quick release was tripped. The crane swung forward to keep the block away from the buoy. The slip line to the buoy deck bail was cleared at about the same time. The ship then maneuvered slowly ahead to allow the buoy to come around to the stern.

The winch operator slowly hauled in the slack wire once the buoy had drifted behind the ship. The ship's speed was increased to .5 knot through the water to maintain a safe distance between the buoy and the ship. The bottom end of the shot of wire shackled to the working line was pulled in and stopped off at the transom.

A traveling block was suspended from the crane. The free end of the working line was passed through the block. The next instrument, a 62.5 meter depth load bar with SBE 37 MicroCat and pre-attached wire shot was shackled to the end of the stopped off mooring. The bottom of this wire was shackled into top of the working line. The hauling line was pulled onto the TSE winch to take up the slack. The winch slowly took the mooring tension from the stopper lines.

The winch line pulled back, lifting the instrument off the deck as it was raised. The instrument was lifted clear of the deck and over the transom. The winch was payed out to the next termination. The termination was stopped off using lines on cleats, and the hauling wire removed while the next instrument was attached to the mooring.

The next several instruments were deployed in a similar manner. Additional instruments were attached to the mooring wire using clamps. When pulling the slack on the longer shots of wire, the terminations were covered with a canvas wrap before being wound onto the winch drum. The canvas covered the shackles and wire rope termination to prevent

damage from point loading the lower layers of wire rope and nylon on the drum. This process of instrument insertion was repeated for the remaining instruments down to 450 meters.

The winch continued to pay out wire and nylon line until all mooring components that had been pre-wound were payed out. The end of the 200 m nylon was stopped off about 20 feet from the transom using a sling through the thimble.

An H-bit cleat was positioned aft of the winch and secured to the deck. The free end of the 3350 meter shot of nylon/Colmega line, stowed in three wood-lined wire baskets was wrapped onto the H-bit and passed to the stopped off mooring line. The shackle connection between the two nylon shots was made. The line handler at the H-bit pulled in all the residual slack and held the line tight against the H-bit. The stopper lines were then eased off and removed.

The person handling the line on the H-Bit kept the mooring line parallel to the H-bit with moderate back tension. The H-bit line handler and one assistant eased the mooring line out of the wire basket and around the H-bit at the appropriate payout speed relative to the ship's speed. Another person sprayed water on the h-bit to keep the line from overheating.

When the end of the Colmega line was reached, pay out was stopped and a Yale grip was used to take tension off the line. The winch tag line was shackled to the end of the Colmega line. The line was removed from the H-Bit. The winch line and mooring line were wound up taking the mooring tension away from the stopper lines on the Yale grip. The stopper lines and Yale grip were removed. The winch payed out the mooring line until all but one meter of the Colmega line was over the transom.

The 88 glass balls are bolted on 1/2" trawler chain in 4 ball (4 meter) increments. The first set of glass balls was dragged into position and shackled together. One end was attached to the mooring at the transom. The other end was shackled to the winch leader. The winch pulled the mooring line tight, stopper lines were removed, and the winch payed out until three of the four balls were off the stern. Stopper lines were attached, the winch leader was removed, and two more string of glass balls were inserted into the mooring line. This process was repeated until all 84 balls were deployed.

A 1" titanium load bar with two SBE 37 C/T loggers was shackled to the last glass ball segment. After that, a five-meter shot of 1/2" chain was connected to the mooring. The winch took tension on the mooring, stopper lines were removed, and a chain hook connected to the air tugger line running through the block on the a-frame lifted the SBE 37s off the deck. The winch payed out with the tugger, and the instruments were eased over the transom. The tugger went slack, and the chain hook was removed.

The acoustic releases were shackled to the chain. Another 5-meter chain section was shackled to the releases. A 20-meter Nystron anchor pendant was shackled to that chain, and another 5-meter section of 1/2" chain was shackled to the anchor pendant. The

mooring winch wound up these components until it had the tension of the mooring. The acoustic releases were laying flat on the deck.

A chain hook connected to the air tugger line running through the block on the a-frame lifted the acoustic releases off the deck. The winch payed out with the tugger, and the instruments were eased over the transom. The tugger went slack, and the chain hook was removed

The winch continued to pay out until the final 5-meter shot of chain was just going over the transom. A shackle and link was attached one meter up this segment of chain. A heavy-duty slip line was passed through the link and secured to the winch leader. The winch hauled in until tension was transferred to the slip line. The chain lashings were removed from the anchor. The end of the chain was removed from the winch and shackled to the anchor on the tip plate.

At this point, the ship was still 4 nm from the target anchor position. The mooring was towed through the water as preparations to tip the anchor were finalized.

The ships Gilson winch working line was fed through the A-frame block. The a-frame was positioned above the anchor, and the winch working line was connected to the chain bridle on the anchor tip plate. A slight strain was applied to the bridle. The slip line was removed, transferring the mooring tension to the 1/2" chain and anchor. The line was pulled clear and Gilson winch raised the tip plate until the anchor slid off the plate into the ocean.

3) Anchor Survey

Following the anchor drop, the *Cabo de Hornos* moved off the deployment line and allowed time for the anchor to reach the sea floor (Figure 3-6). Three points were selected for the anchor survey at ranges approximately 1 mile from the estimated anchor location.

At each of these sites an Edgetech 8011M deck unit was used to communicate with the acoustic release on the mooring. Signal travel time was recorded at each site. Travel time and ship's coordinates for each site were entered into Arthur Newhall's Acoustic Survey Software to calculate anchor position. The program uses the intersection of each range arc to calculate anchor position, see Figure 4-1.

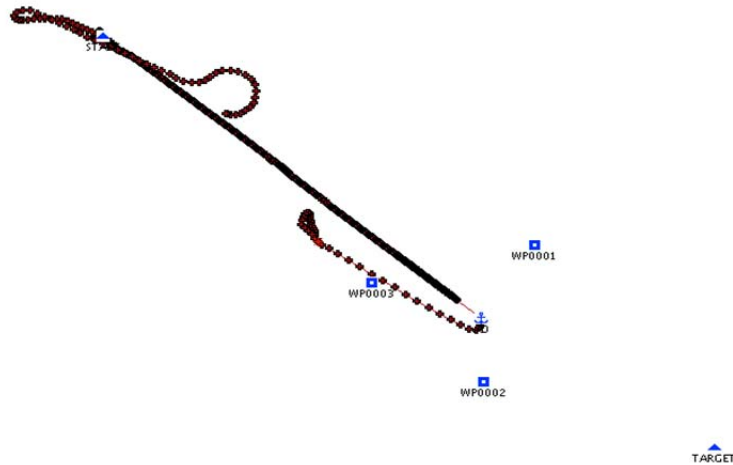

Figure 3-6. The track of the *Cabo de Hornos* during the deployment of Stratus 14. The ship initially return to the start point to the northwest and then makes its way down the track to the southeast. Also shown are the three points used for the acoustic survey of the anchor location (WP0001, WP0002, WP 0003).

Three positions were provided to the bridge. At each position the ship stopped, and the over the side hydrophone and acoustic release deck box were used to obtain ranges and travel times from the ship to the acoustic release above the anchor. The survey points and results are shown in Table 3-7. Three ranges and travel times were obtained at each survey point to ensure the ranging was repeatable.

Table 3-7. Acoustic ranging results for anchor survey of Stratus 14.

Survey Waypoint	Latitude	Longitude	Travel time (s)	Range (m)
1	19° 48.102' S	084° 43.585' W	6.615	4961
1	19° 48.100' S	084° 43.585' W	6.612	4959
1	19° 48.095' S	084° 43.585' W	6.609	4956
2	19° 50.019' S	084° 44.379' W	6.509	6.509
2	19° 50.011' S	084° 44.382' W	6.501	6.501
2	19° 50.006' S	084° 44.387' W	6.494	6.494
3	19° 48.415' S	084° 45.842' W	7.019	5264
3	19° 48.408' S	084° 45.839' W	7.016	5262
3	19° 48.397' S	084° 45.817' W	7.019	5264

These survey results were used with several programs to estimate the anchor position. Water depth was taken to be 4510 m based on the bathymetric survey. The release is located 34 m off the bottom.

A Matlab routine (Weller code) gave Figure 3-7. An older Matlab code (Weller) gave Figure 3-8. Angulate gave Figure 3-9. Art Newhall's program gave Figure 3-10 and 3-11.

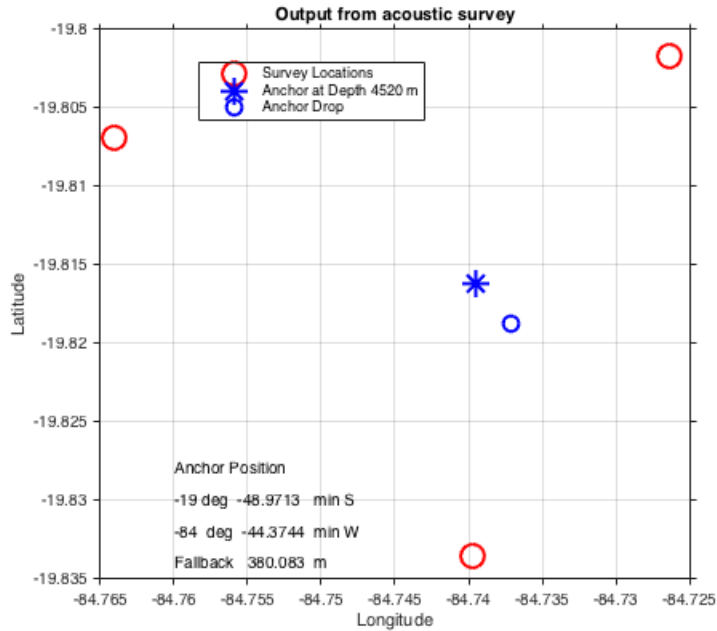

Figure 3-7. Anchor survey results using Anchpos code from Weller.

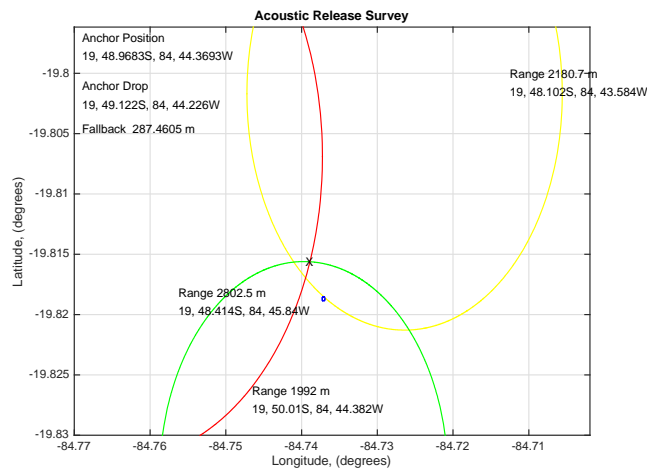

Figure 3-8. Anchor survey results using older Ecours code.

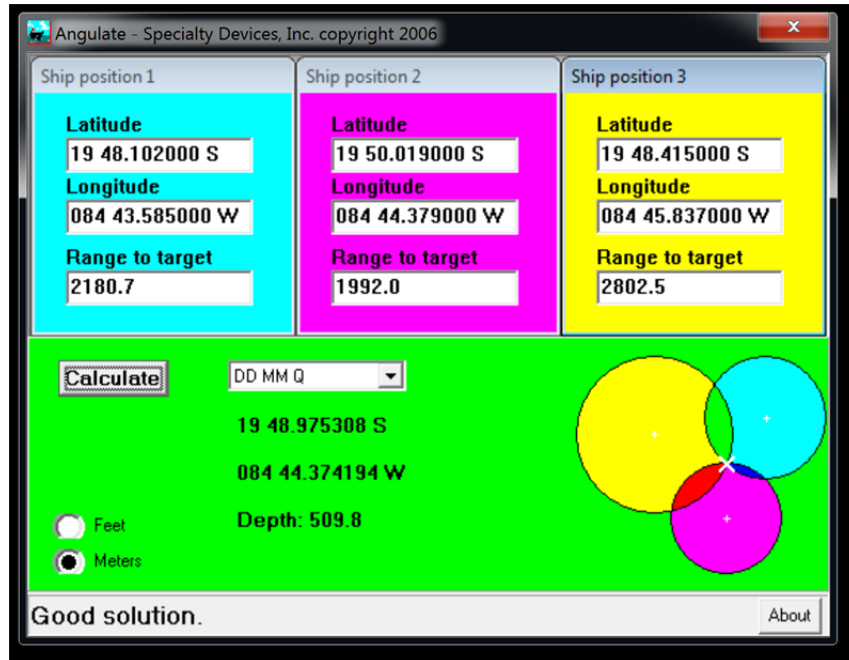

Figure 3-9. Anchor survey results using Angulate.

Enter initial position of the target

Latitude deg minutes N S
 Longitude deg minutes W E
 Depth (m)

Number of Surveys

Push EDIT and enter your survey positions with this format:
 Lat(deg) Lat(min) lon(deg) lon(min) travel_time (secs)
 1-way 2-way

Ave. Soundspeed (m/s) Transponder depth (m)

Plotting Variables....

X axis begin
 X axis end
 Y axis begin
 Y axis end

Calculated lat,lon position is:

lat N: -19 deg -48.9796 min
 lon E: -84 deg -44.3685 min

Figure 3-10. Anchor survey setup and result from Art Newhall's program.

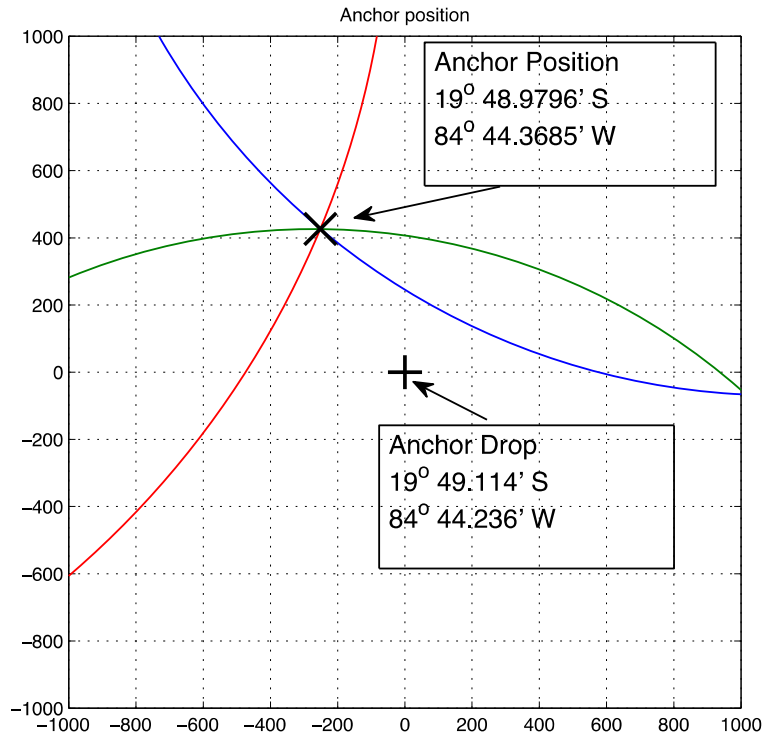

Table 3-8 summarizes the results. The solution shown in Figure 3-7 was selected as the anchor position for the mooring log.

Table 3-8. Stratus 14 anchor position results from various codes. Newhall * results are based on average of 3 positions surveys and 2-way travel times; transit times were also multiplied by a factor 1500 /1509 to account for deck box setting of sound speed at 1500 m s^{-1} instead of actual value of 1509 m s^{-1} .

Code	Latitude	Longitude	Fall Back (m)	Water Depth (m)
Anchpos	19° 48.9713' S	084° 44.3744' W	380	4520
Ecours	19° 48.9683' S	084° 44.3693' W	287	
Angulate	19° 48.9753' S	084° 44.3742' W		
Newhall	19° 48.9812' S	084° 44.3673' W		
Newhall *	19° 48.9796' S	084° 44.3685' W	340	

F. Measurements Inter-comparisons

1) Meteorological Instrumentation

Before departure from Valparaiso on April 16, Sergio Pezoa (NOAA) mounted the ESRL met tower on the bow of the O2 deck (Figure 3-12) and radiometers on O3 deck (Figure 3-13). Sergio brought down the tower after recovery of Stratus 13 buoy on April 24. During transit, the sonic wind sensor on top of the ESRL tower was damaged by a bird and replaced with a spare sonic sensor. During inter-comparison, an apparent offset (30 to 40 degrees) in wind direction was seen in the measurements between ESRL and buoy/ship; we concluded this was due to a different setup of the reference heading (spar vs transducer) for the spare sonic.

The ESRL instrumentation on the bow tower consists of a sonic wind, relative humidity and air temperature, a fast response Licor sensor for turbulent measurements of humidity, and a motion package. Radiometers SWR, LWR Eppleys were mounted on a platform on O3 deck (one deck below wheelhouse), next to railing on starboard side (possible shade from wheelhouse at times). Finally, a seasnake was mounted on the port bow and measured SST, completing ESRL measurements.

The *Cabo de Hornos* is also equipped with a Vaisala weather station, located on a mast above the wheelhouse (Figure 3-14), approximately 24.5 m above sea level (ASL). Most ASIMET instruments on WHOI buoys are between 3.2 and 3.5 m ASL. Heights of meteorological instrumentation are summarized in Table 3-9.

Table 3-9. Instrumentation used for inter-comparison with ORS Stratus buoy.

Sensor	Height ASL (m)	Comment
ESRL Sonic	15.6	10 Hz
ESRL AT/RH	14.1	0.1 Hz, averaged to 1 sample / minute
ESRL Licor7500	14.3	10 Hz
ESRL Barometer	12	0.1 Hz, averaged to 1 sample / minute
ESRL Seasnake	-0.05 to -0.10	0.1 Hz, averaged to 1 sample / minute
ESRL ORG	14.5	0.1 Hz, averaged to 1 sample / minute
ESRL Motion Package	15.1	10 Hz
Ship BPR, AT/RH, Sonic	24.5	



Figure 3-12. ESRL meteorological tower on bow, O2 deck.



Figure 3-13. ESRL radiations sensors, near starboard railing tower on O3 deck.



Figure 3-14. Ship meteorological at top of mast, above wheelhouse.

Nancy Galbraith accessed ESRL data on Sergio's machine through a local network connection and produced Matlab files called `esrl.mat`, `esrlflux.mat` (1-minute data) and `esrlflux30.mat`. After the inter-comparison period, Sergio reprocessed his wind data to take into account a 30 degree offset. Nancy produced a new file called `swnd.mat`, which had this new corrected wind (`esrl.mat`, `esrlflux.mat` and `esrlflux30.mat` were left unchanged). However, a quick look at inter-comparison data (using `swnd.mat`) showed this correction produced negative effects on ESRL's wind speed and direction when compared to buoy/ship sensors. Sergio advised to wait for post-processing to be done at Boulder so that the correction is consistently applied in software. After the cruise, Byron Blomquist provided re-processed ESRL's data, in particular wind data, and some plots that indicated a strong improvement.

Buoy data is based on telemetry and contains hourly averages. Telemetry was picked up with Alpha Omega receiver while at sea without internet connection. UOP website may contain more data if necessary, obtained from satellite transmissions. For inter-comparison data presented here, Sebastien Bigorre merged the Alpha Omega and satellite telemetry data.

During the periods of inter-comparison with Stratus 14 and 13 buoys, the ship was stationed downwind of the buoy for several hours and compare measurements from the buoy (acquired through hourly telemetry) and sensors mounted on the ship. Note that the night watch did not always maintain position with bow into wind and downwind of buoy. During this cruise, the periods of inter-comparison were:

- near Stratus 14: April 21 21:00 UTC to April 22 20:00 UTC
- near Stratus 13: April 22 22:00 UTC to April 24 12:00 UTC

The ship sailed away momentarily from each buoy on a few occasions for CTD casts (~ 2 hours on April 22 13:00 UTC, and again on April 23 13:00 UTC), or for engine maintenance on April 23 from 22 to 23 UTC. These events are apparent in figures 3-15 to 3-16, using ESRL data for ship speed on ground (SOG), wind speed and direction relative to ship. Short rain events occurred during the few days we were in the Stratus area, which are shown in figure 3-17.

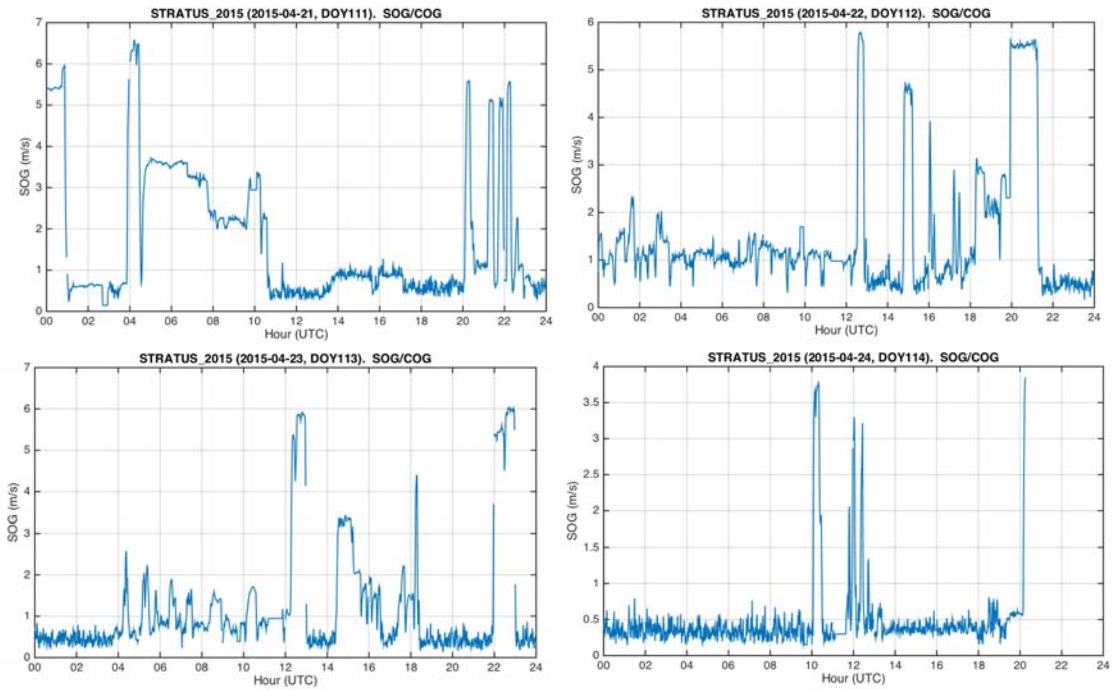

Figure 3-15. Ship's speed on ground from ESRL instrumentation, during inter-comparison periods at Stratus 14 and Stratus 13 sites.

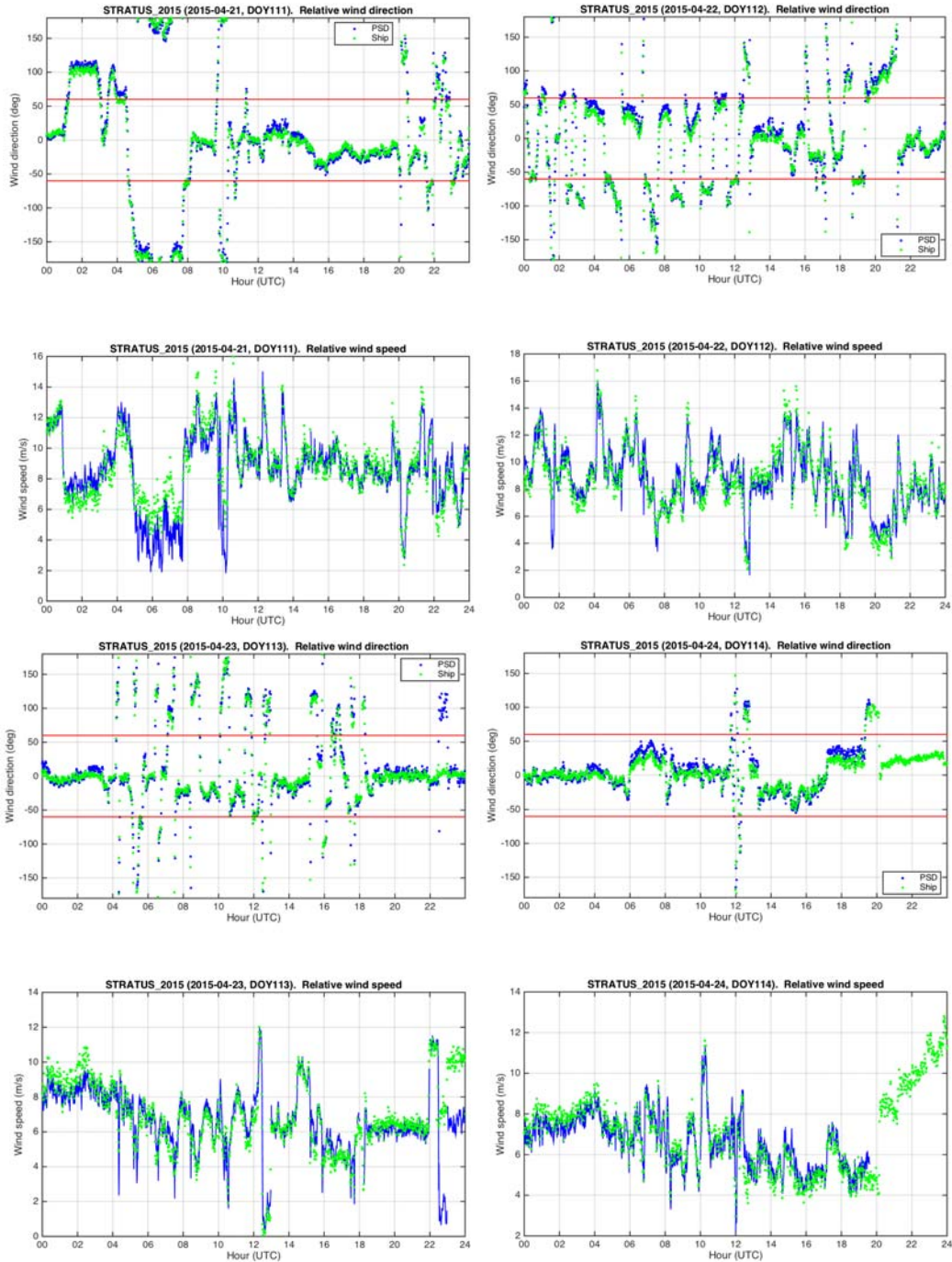

Figure 3-16. Relative wind speed and direction from ESRL and ship instrumentation, during inter-comparison periods at Stratus 14 and Stratus 13 sites.

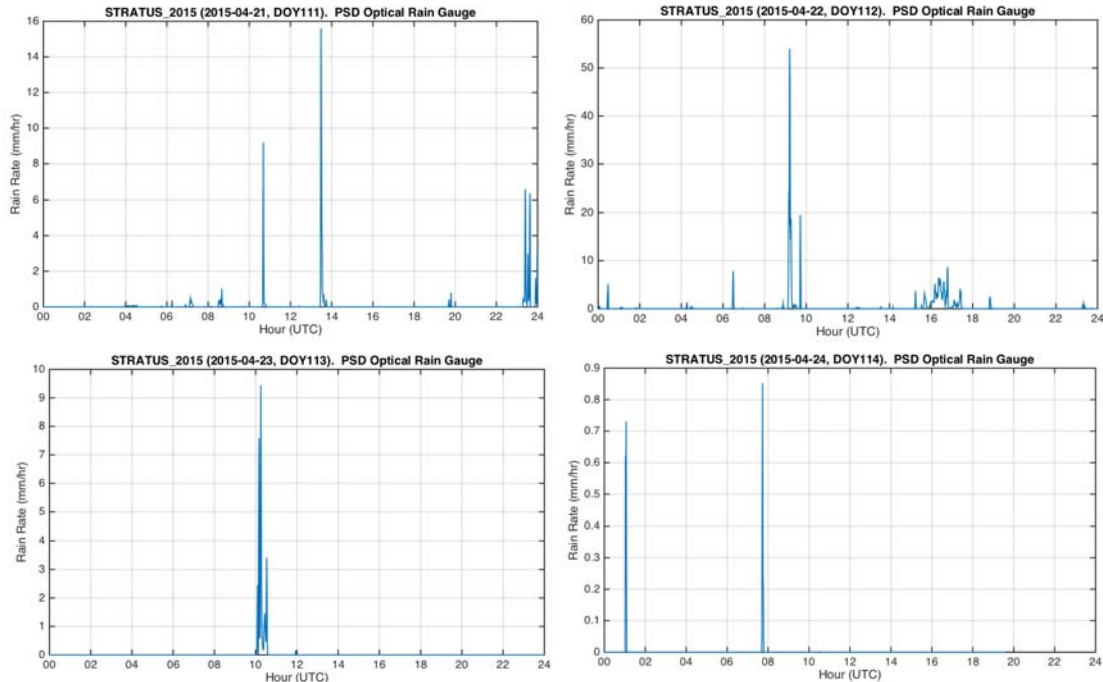

Figure 3-17. Rain rate from ESRL instrumentation, during intercomparison periods at Stratus 14 and Stratus 13 sites.

2) Intercomparison results

Air-sea fluxes were computed using telemetered data (hourly) from system 2 on the freshly deployed Stratus 14 buoy and the COARE 3.5 bulk algorithm. The inter-comparison period at Stratus 14 lasted from April 21 21:00 UTC to April 22 20:00 UTC. During this period the ship was stationed about $\frac{1}{4}$ nm downwind of the buoy. The ship sailed away momentarily (< 2 hours) from the buoy for a CTD cast on April 22 13:00 UTC. In order to compare air temperature (ATMP) and humidity (SH) and wind speed (WSPD) whose values depend on measurement height, data from sensors on the ship were adjusted to the same height as the ASIMET sensors on the buoy. The adjustment was made using the bulk flux algorithm COARE 3.5. Profiles for these quantities were also estimated onto a high-resolution vertical vector and using hourly data averaged over the inter-comparison period. The profiles were constructed using telemetered data from system 2 on Stratus 14 buoy. The data consisted of quantities measured at the ASIMET height as well as estimates of their surface values (SST for air temperature, specific humidity at surface using 100%RH and SST, and assuming zero wind speed at the air-sea interface). The COARE 3.5 algorithm then computes the Monin-Obukhov length and roughness lengths and the atmospheric stability functions to extrapolate the point estimates at any other height within the surface boundary layer.

Figure 3-18 shows the time-series of air temperature from the buoy during the Stratus 14 inter-comparison period. Also shown are data from sensors on the ship (including ESRL's) both at measurement height and at buoy height using adjustment from COARE 3.5. Figures 3-20 and 3-21 show similar time-series for specific humidity and wind speed.

Figure 3-19 shows the vertical profile of air temperature as estimated by COARE 3.5 using the telemetered data from system 2 on stratus 14. Colored symbols denote the average values during the inter-comparison for different sensors. Horizontal colored lines centered on these symbols represent one standard deviation of the difference between measurements from each sensor and the time-varying profile values. The grey dots at the bottom of the profiles represent the surface values used to construct the profiles. Figures 3-20 and 3-22 show similar profiles for air specific humidity and wind speed. From these figures, specific humidity from system 1 (2) on Stratus 14 buoy is about 0.2 g kg^{-1} (0.4 g kg^{-1}) higher than ESRL's values, and ship's values are even lower. For environmental conditions present during inter-comparison (ATMP $\sim 20 \text{ }^\circ\text{C}$, BPR $\sim 1016 \text{ mb}$, SH $\sim 12 \text{ g kg}^{-1}$, HRH $\sim 83\%RH$) a 0.2 g kg^{-1} difference in specific humidity is equivalent to 1.4 \%RH relative humidity. Wind speed from buoy is lower than ship's and slightly higher than ESRL; the latter has a large variability, which may have been caused by flow distortion when ship was not headed into the wind. Air temperature agrees quite well between buoy and ship measurements.

Time-series of shortwave (SWR) and longwave (LWR) radiation measurements are shown in figures 3-25 and 3-27, as well as scatter plots in figures 3-24 and 3-26. Root mean square error between different sensors and system 2 on stratus 14 are shown in scatter plots. SWR data from buoy shows relatively large discrepancies with ESRL's, but no bias. LWR from ESRL agreed well with -although slightly lower than - the Stratus 14 sensors.

BPR measured on ship were adjusted to same height as sensors on stratus 14 buoy and shown in figure 3-28. There is good agreement to the extent that the telemetered data has poor resolution (rounded off to lower integer).

Figure 3-29 shows comparison of the measurements of salinity and temperature of water near the surface, using CTD cast done during inter-comparison period at Stratus 14 site. For this comparison, CTD data used was restricted to upper 10 m, which was well within the mixed layer (mixed layer depth was close to 50 m near Stratus 14). Note that telemetered data from Stratus 14 is limited in accuracy (for bandwidth conservation), especially in conductivity (0.01 S m^{-1} resolution). Two estimates for telemetered data buoy were used: one was an average over whole inter-comparison period and the other one (spot) was the measurement closest in time from the CTD cast. Temperature data from ESRL's seasnake (which samples the upper 5 cm of the ocean) was also used and treated in a similar way. Average SST values from buoy and ESRL are very close to each other and within about $0.01 \text{ }^\circ\text{C}$ of CTD data. Spot SST values from buoy are about $0.025 \text{ }^\circ\text{C}$ lower than CTD and ESRL values. Salinity values are within 0.05 psu.

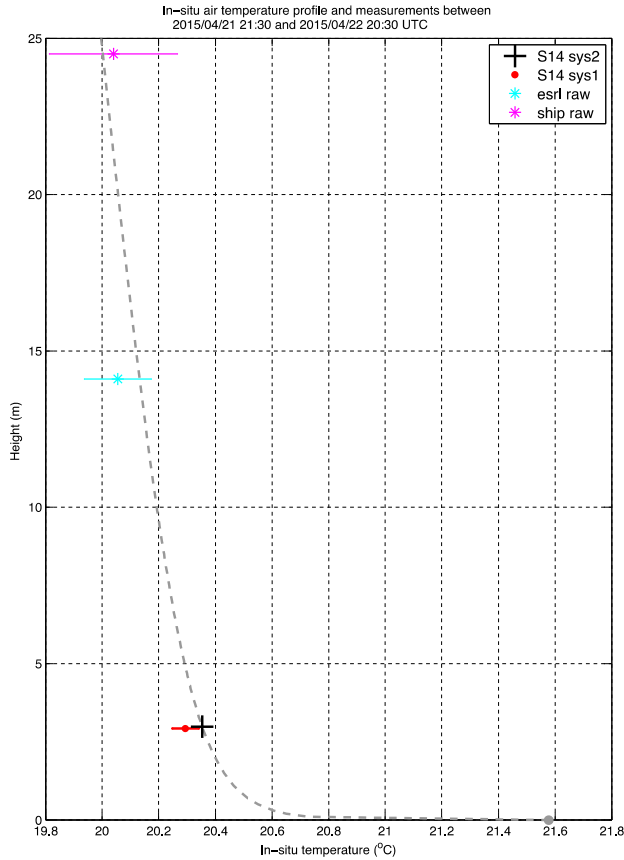
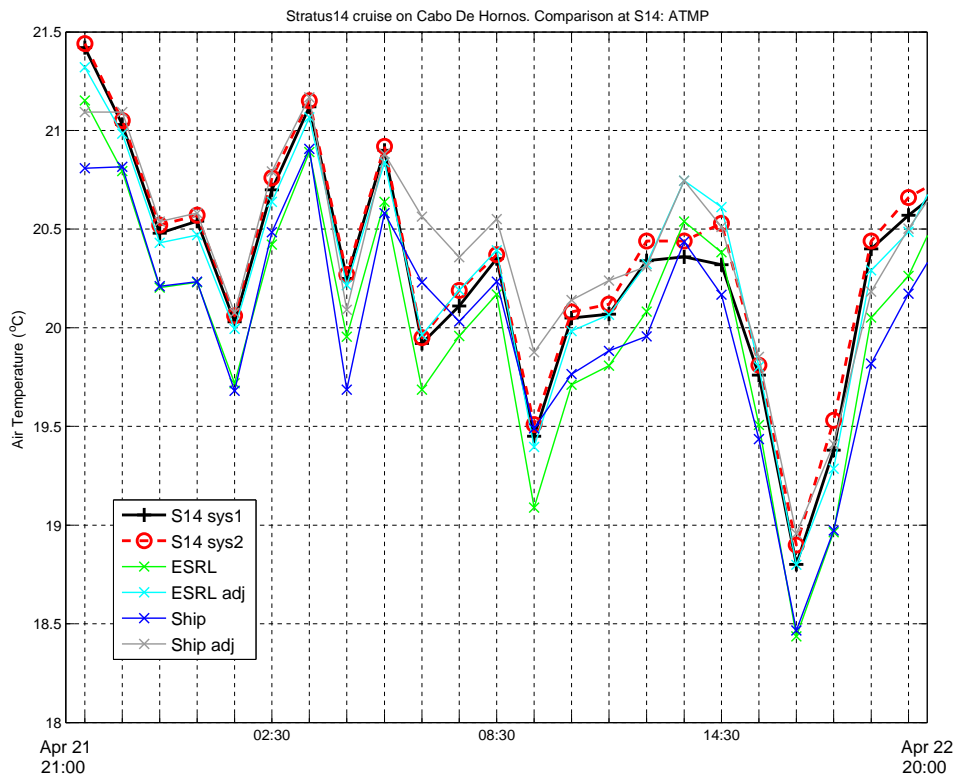

Figure 3-18 (left). Vertical profile of in-situ air temperature during inter-comparison at Stratus 14 mooring. Grey dashed line is profile using 24-hour average of telemetry data from system 2 on S14 and COARE 3.5. Surface value is SST from same source. Colored symbols and horizontal lines denote mean and standard values of available data from sensors on buoy and ship (including ESRL) and their difference with the average profile.

Figure 3-19 (below). Time series of in-situ air temperature during inter-comparison at Stratus 14 mooring. ESRL and ship data are both raw and adjusted to height of sensors on buoy.



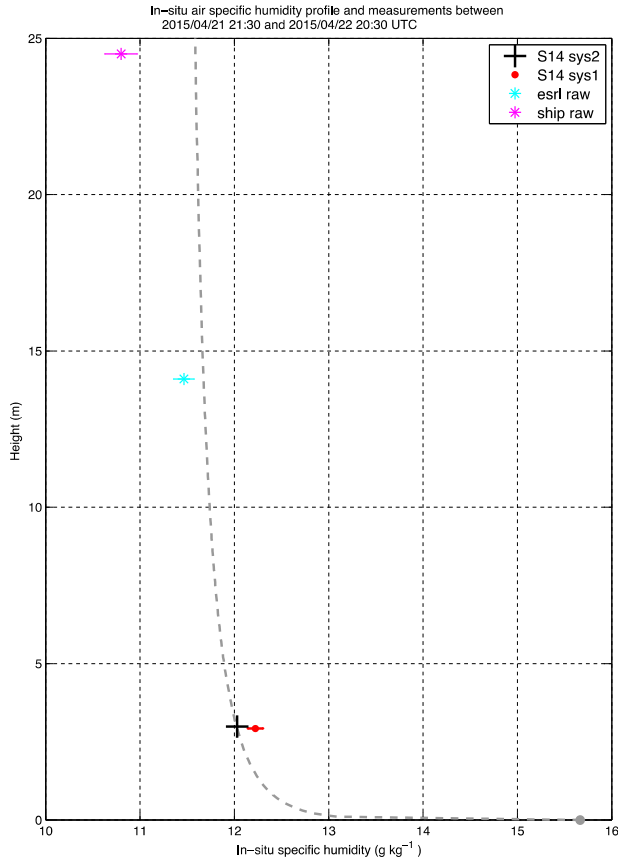
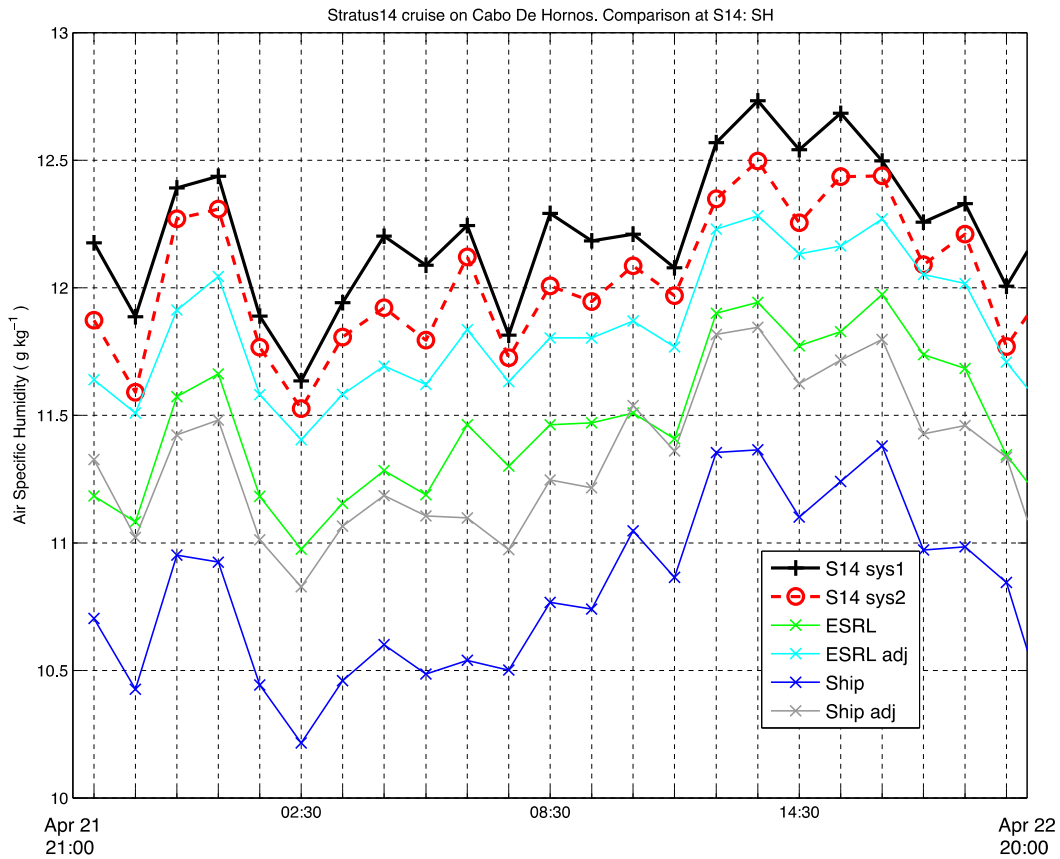

Figure 3-20 (left). Same as Fig. 3-18 but for air specific humidity.

Figure 3-21 (below). Same as Fig. 3-19 but for air specific humidity.



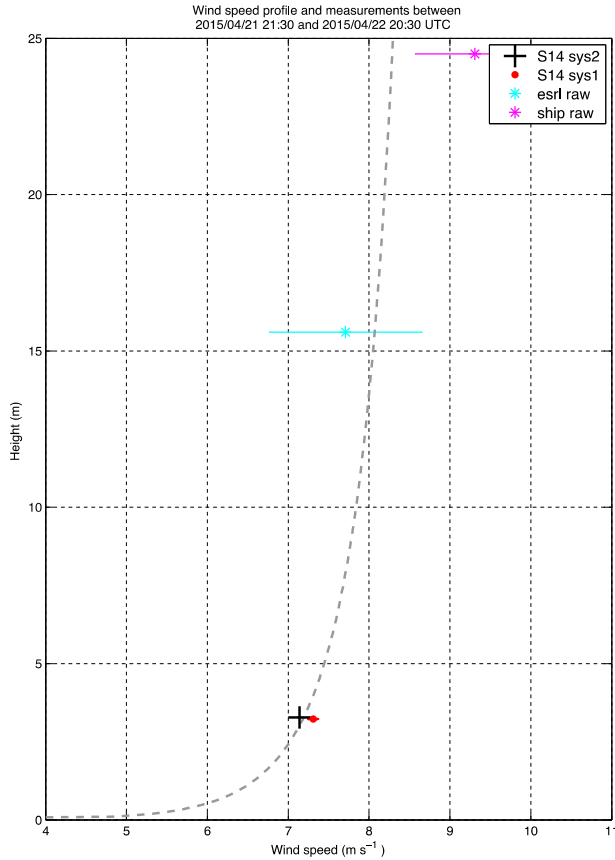
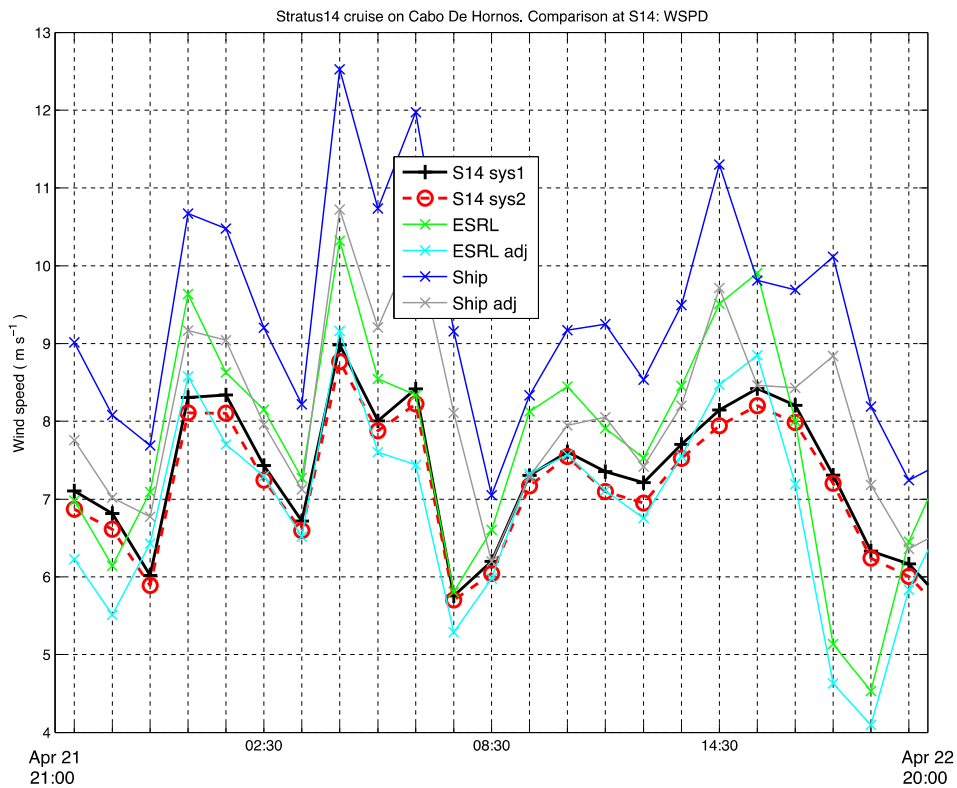

Figure 3-22 (left). Same as Fig. 3-18 but for wind speed.

Figure 3-23 (below). Same as Fig. 3-19 but for wind speed.



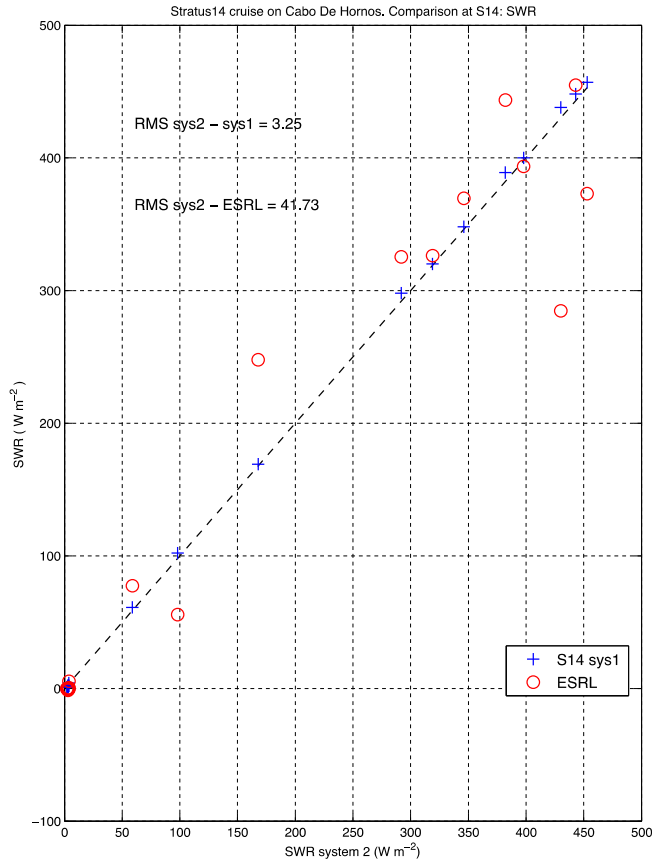
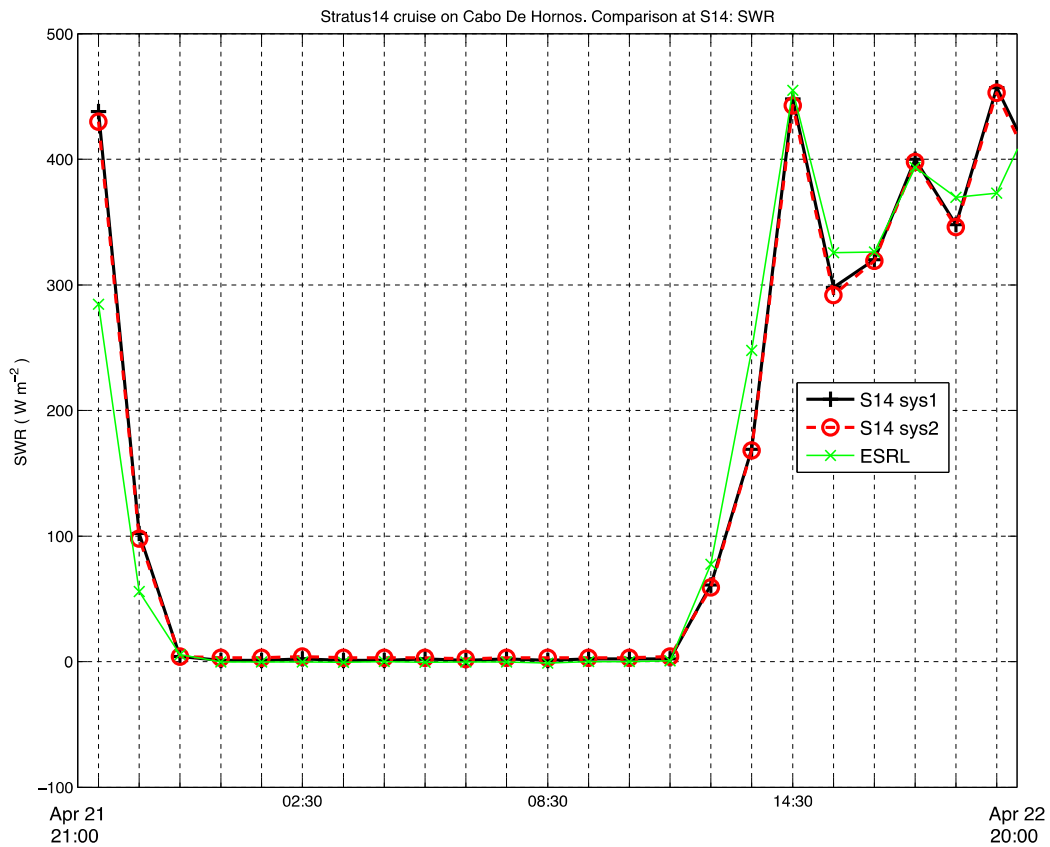

Figure 3-24 (left). Scatter plot of SWR difference between system 2 on Stratus 14 and other sensors, during inter-comparison.

Figure 3-25 (below). Time-series of SWR from buoy and ESRL during inter-comparison at Stratus 14 buoy



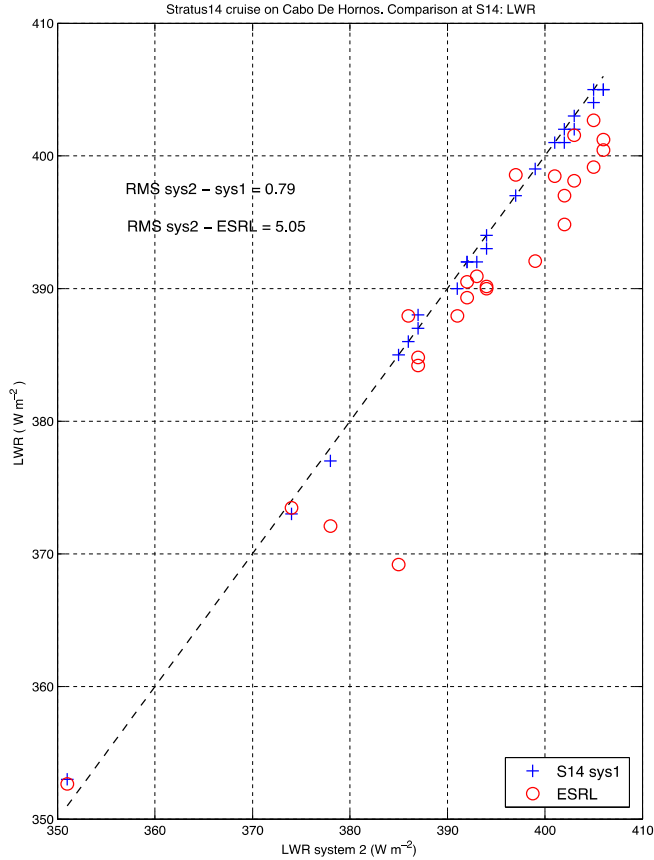

Figure 3-26 (left). Scatter plot of LWR difference between system 2 on Stratus 14 and other sensors, during inter-comparison

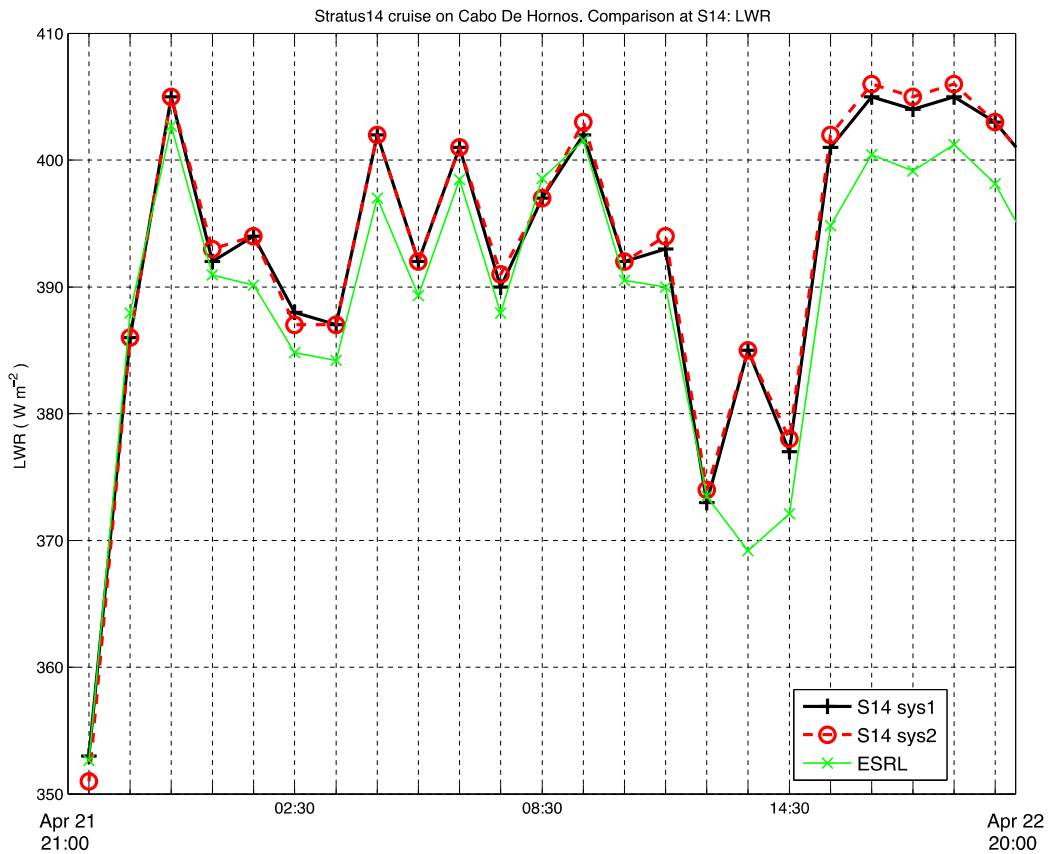

Figure 3-27 (below). Time-series of LWR during inter-comparison at Stratus 14 buoy.

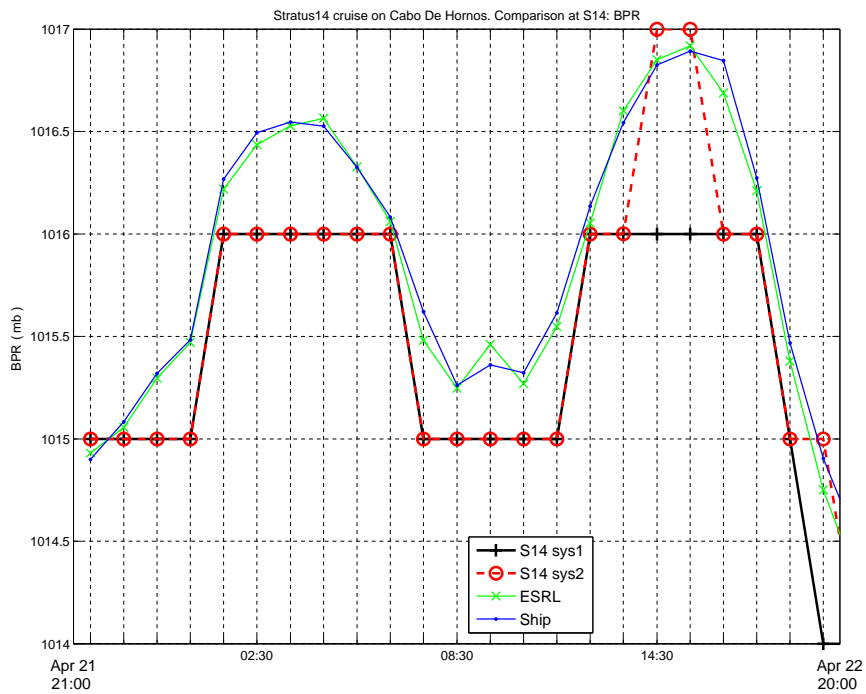

Figure 3-28. Time-series of BPR during inter-comparison at Stratus 14 buoy

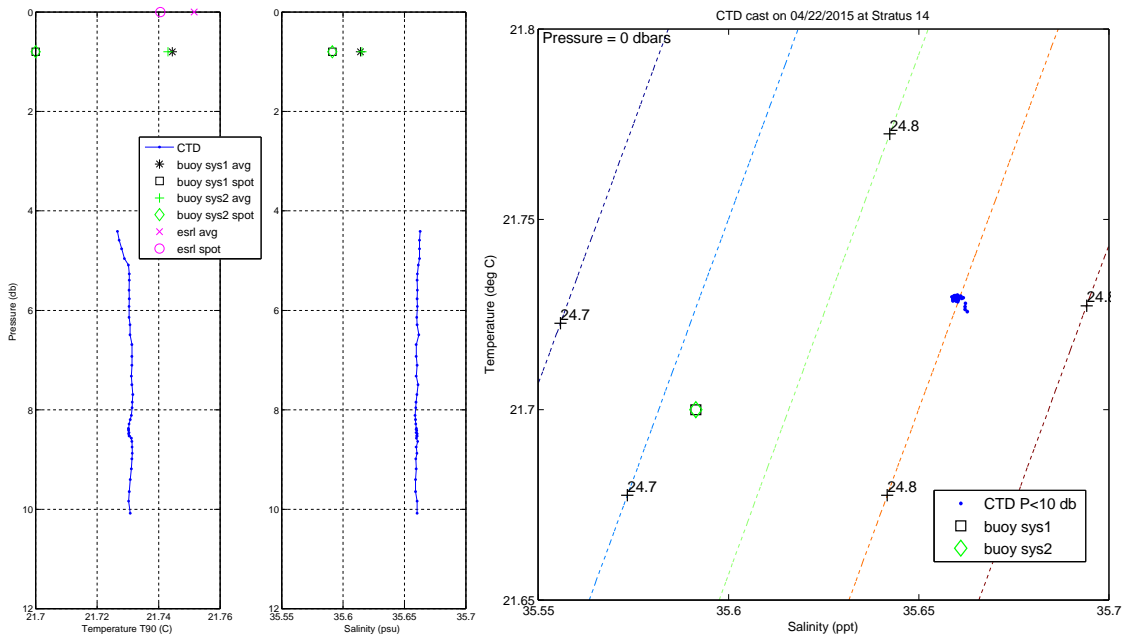

Figure 3-29. Comparison between CTD cast and Stratus 14 data: SST and salinity. Left: profiles of temperature (left) and salinity (center) for upper 10 m of CTD cast; symbols at surface denote buoy data (black, green) and ESRL (magenta). Right: same data shown as T-S plot.

IV. Stratus 13 Mooring

A. Mooring Recovery

The Stratus 13 mooring was recovered on April 24, 2015. To prepare for recovery the vessel was positioned roughly ¼ mile to the side of the anchor position, with the buoy streaming down wind. The release command was sent to the acoustic release to separate the anchor from the mooring line. After about 50 minutes, the glass balls surfaced. Once the glass balls were on the surface, the ship approached the cluster of balls along the port side. The ship's work boat was deployed to connect a lifting sling into the glass ball cluster. A messenger line was used to pass the lifting line from the ship to the rescue boat, where the lifting sling and lifting line were shackled together. The rescue boat was recovered before the recovery commenced.

The winch hauled in as the ship steamed ahead to get the balls lined up behind it. At this point, the ship was towing the glass balls from the Gilson winch, with the rest of the mooring trailing behind. With the A-frame positioned outboard, the glass balls were slowly lifted from the water. The A-frame was brought inboard as the winch hauled in, lifting the cluster of glass above the deck. A second Gilson winch was used to take a second bite on the glass ball cluster to bring it completely on board. Two air tuggers were used to stabilize the cluster, and haul it forward. When the cluster was clear of the transom; it was lowered to the deck. A stopper line was used to secure the chain hanging over the stern with two SBE 16s and two acoustic releases attached to it. Another stopper line was connected to the thimble on the end of the Colmega line. The winch was disconnected from the glass ball cluster, and shackled to the release chain. The chain was disconnected from the glass ball cluster, and the winch hauled in to get the SBE 16s and releases onto the deck.

The glass balls were disconnected and hauled to the starboard side to be lifted by crane into the ragtop container on the main deck. The ship continued to steam slowly into the wind during this operation. Once the deck was clear, a traveling block was hung from A-frame, using the large air tugger to adjust the height. The winch leader on the 01 net drum was connected to the thimble on the Colmega line. The winch hauled in all of the 3300 meters of synthetic line and all of the wire rope. VMCMS and instruments clamped to the wire rope were removed as they came to the surface.

For instrument recovery, the a-frame was positioned about 4 feet forward of the stern. A traveling block remained in place. Height was adjusted with the large air tugger. The winch hauled in the wire. Instruments on load bars or in cages were stopped about 3 feet above the deck. Two stopper lines were hooked into the sling link and made fast to the deck cleats. The winch payed out slowly to lower the instrument to the deck. The instrument was disconnected from the hardware and moved to a staging area for pictures. The wire rope from the winch was then shackled to the load. The winch took up the slack and the stopper lines were eased off and then cleared. Hauling continued until the next instrument.

The above procedure was continued throughout the recovery operation until the Sea-Bird SBE 39 at 55 meters was recovered. Then a slip line, passed through the link at the bottom of the 16-meter wire shot was used to set the buoy and remaining 50 meters of instruments adrift.

Once the buoy was set adrift from the stern recovery operation, the *Cabo de Hornos* made an approach on the starboard side to recover the buoy. A pickup sling with a 50 meter piece of buoyant line and a float had been attached to the buoy pickup bale the previous day. The crane was positioned above the recovery area. As the ship maneuvered by the buoy, a grappling hook was used to recover the pickup line and connect the lifting sling to the crane hook. The crane lifted the buoy from the water and swung inboard so the buoy would rest on the side of the ship. A tugger line was attached to a buoy deck bale, and a steadying line was looped through the crash bar on the tower on the buoy. The buoy was hoisted up and then swung inboard while the tugger and line kept the buoy from swinging.

Once the buoy was on deck aircraft straps were used to secure the buoy. A stopper line was used to stop off on the 1.3 m shot of 3/4" chain between the third and fourth instruments. Tugger lines were removed from the buoy. The shackle below the 4.9 meter SBE 39 was removed to disconnect the mooring line from the buoy.

A 6-foot sling was placed through the link at the top of the first instrument and hooked in the crane's hook. The crane took the load, and the stopper line was eased off and cleared. The crane hoisted the first two instruments. A stopper was attached to the link below the instruments hanging from the crane. Once the tugger had the load, the crane lowered the instruments to the deck. The instruments were disconnected and the crane was repositioned over the load. The sling was placed through the sling at the top of the remaining instrument array hooked into the crane. The crane took the load and the stopper line was cleared. The crane lifted the next section of instruments and the above procedure was repeated to recover the remaining instruments.

B. Intercomparison: ship vs Stratus 13 buoy

The ship stationed near Stratus 13 between April 22 22:00 UTC and April 24 12:00 UTC for inter-comparison with the buoy. The ship sailed away momentarily on April 23 13:00 UTC, and on April 23 from 22 to 23 UTC.

Air temperature (ATMP) measurements from ASIMET sensors on the buoy were consistent with each other, and remarkably well correlated (Figure 4-2). The average difference between the two primary sensors was only 0.03 °C during the inter-comparison (Figure 4-1). The standalone ASIMET was about 0.05 °C higher than the primaries and its data was noisier than the primaries. ASIMET ATMP also agreed well (both in correlation and magnitude) with ESRL. Ship's ATMP also correlated well but seemed higher than ASIMET overall. SBE39AT was noisier than ASIMET and 0.1 °C

higher on average. Vaisala WXT 520 and Lascar were noisier and 0.3 °C higher, beyond one standard deviation (Figure 4-1).

For specific humidity, ASIMET primary on system 2 agreed with ESRL, whereas system 1 was comparatively 0.4 g kg⁻¹ low (Fig 4-4). The WXT 520, which typically measures low RH in all our deployments, was also low during this inter-comparison and similar to system1. Standalone ASIMET and Lascar are 0.4 g kg⁻¹ high. Ship's humidity measurement is low, consistent with results from inter-comparison at Stratus 14.

Wind speed measured from both primary ASIMET was very similar (Fig. 4-5, 4-6). The standalone was comparatively 0.3 m s⁻¹ low and similar to the WXT 520. ESRL agrees well with buoy, once adjusted for height, and after using the correct orientation of sensor and motion correction. Ship's wind speed was 0.5 m s⁻¹ high, but this could be due to flow distortion from the ship's structure.

Shortwave solar radiation (SWR) from ASIMET sensors on Stratus 13 buoy was much lower than ESRL at mid-day (difference larger than 100 W m⁻²). In addition, system 1 showed measurements quite different from other sensors (Fig. 4-7, 4-8). It was noted at recovery that one of the ASIMET SWR sensors had stains on its dome (bird droppings), which may explain the difference with the other ASIMET.

Longwave radiation (LWR) from ASIMET sensors on Stratus 13 buoy was within approximately 10 W m⁻² of the ESRL values (Fig. 4-9, 4-10). Both ASIMET agreed quite well with each other, within 5 W m⁻².

Barometric pressure (BPR) from ASIMET sensors on Stratus 13 buoy agreed well with each other and ESRL and ship's values adjusted for height (Fig. 4-11, 4-12).

Finally, a CTD cast was made near Stratus 13 on April 23 13:00 UTC and this measurement was compared with the conductivity and SST data telemetered from Stratus 13 buoy. According to Figure 4-13, SST from the two ASIMET sensors on Stratus 13 agree very well with each other and are 0.03 C warmer than the values from the CTD cast. This difference could be due to horizontal inhomogeneity or different measurement depths. However, salinity on system 2 is 0.018 psu lower than system 1 on stratus 13. System 1 is lower than CTD values by the same amount but again this could be due to different environmental conditions between buoy and ship.

Based on this inter-comparison, it is recommended that particular attention be given to HRH and SWR sensors upon return from the cruise. Conductivity sensors are always calibrated post-cruise and special attention should be given to sensor on system 2. Post-cruise calibrations will be especially valuable for these instruments.

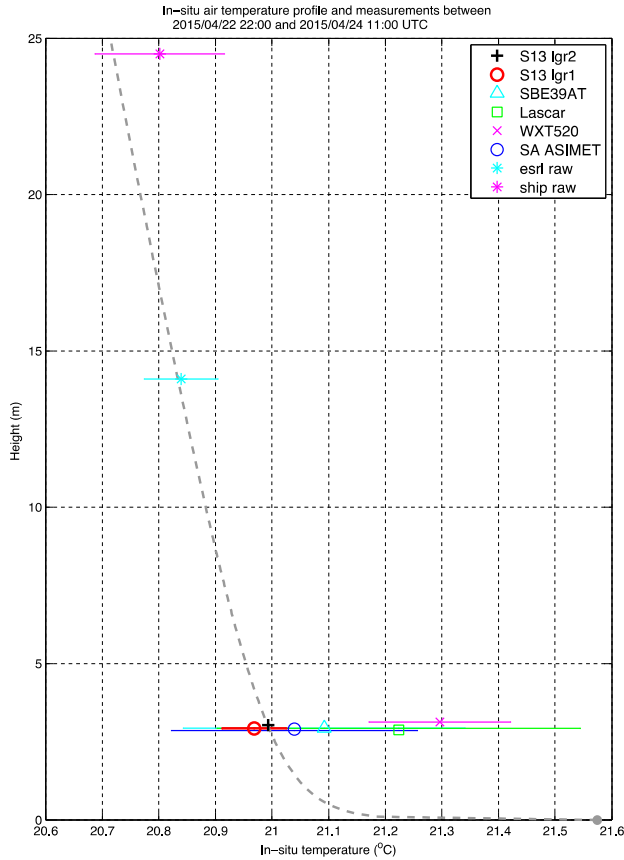
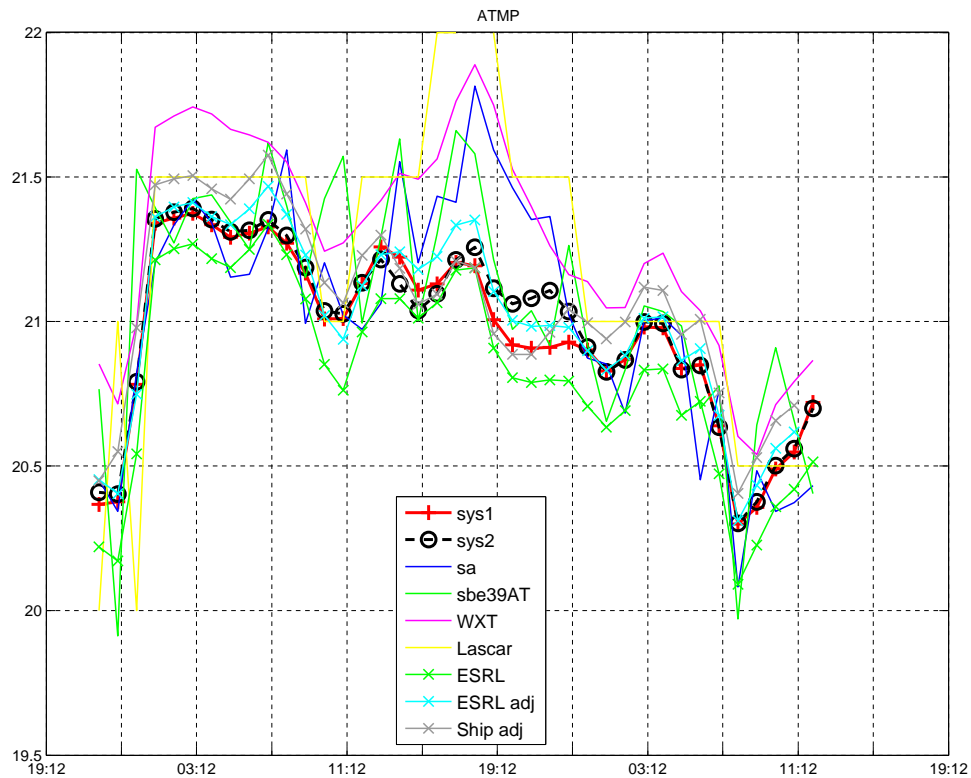

Figure 4-1 (left). Vertical profile of in-situ air temperature during inter-comparison at Stratus 13 mooring. Grey dashed line is profile using 24-hour average of telemetry data from system 2 on S13 and COARE 3.5. Surface value is SST from same source. Colored symbols and horizontal lines denote mean and standard values of available data from sensors on buoy and ship (including ESRL) and their difference with the average profile.

Figure 4-2 (below). Time series of in-situ air temperature during inter-comparison at Stratus 13 mooring. ESRL and ship data are both raw and adjusted to height of sensors on buoy.



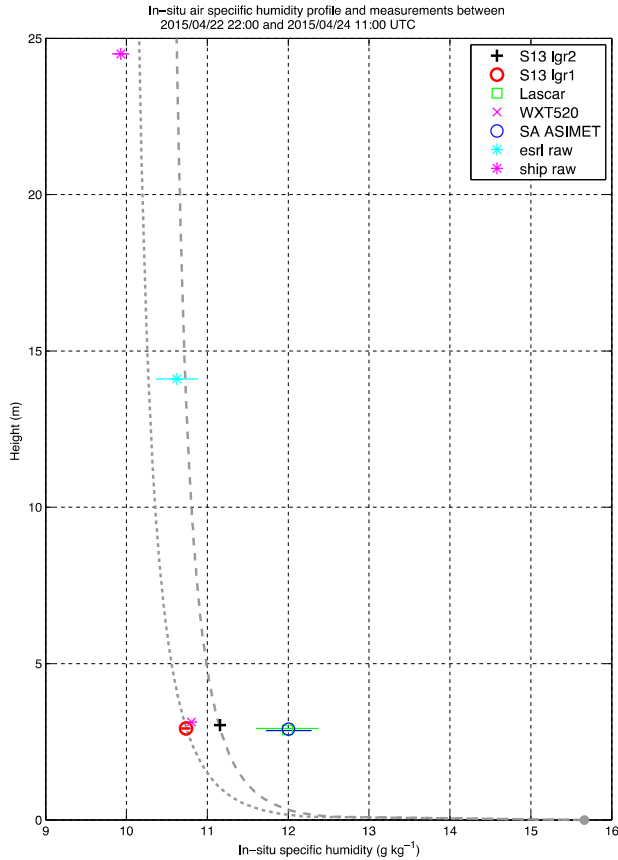
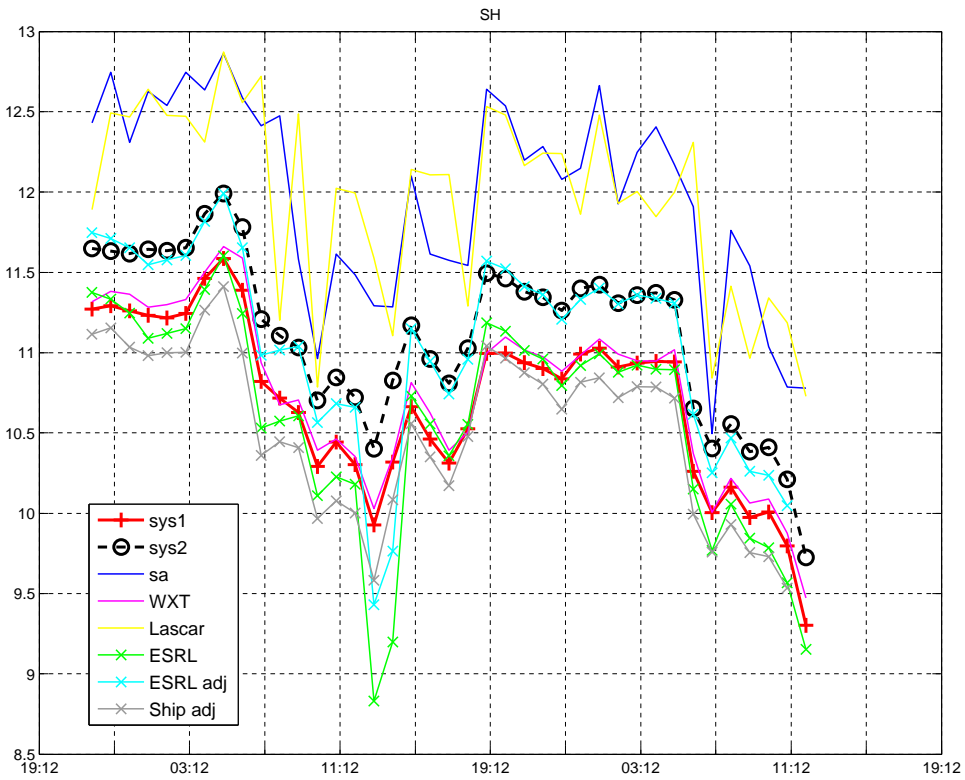

Figure 4-3 (left). As in Figure 4-1 but for specific humidity. Additional profile (grey dotted line) is based on ASIMET system 1 data, adjusted through COARE 3.5.

Figure 4-4 (below). As in Figure 4-2 but for specific humidity.



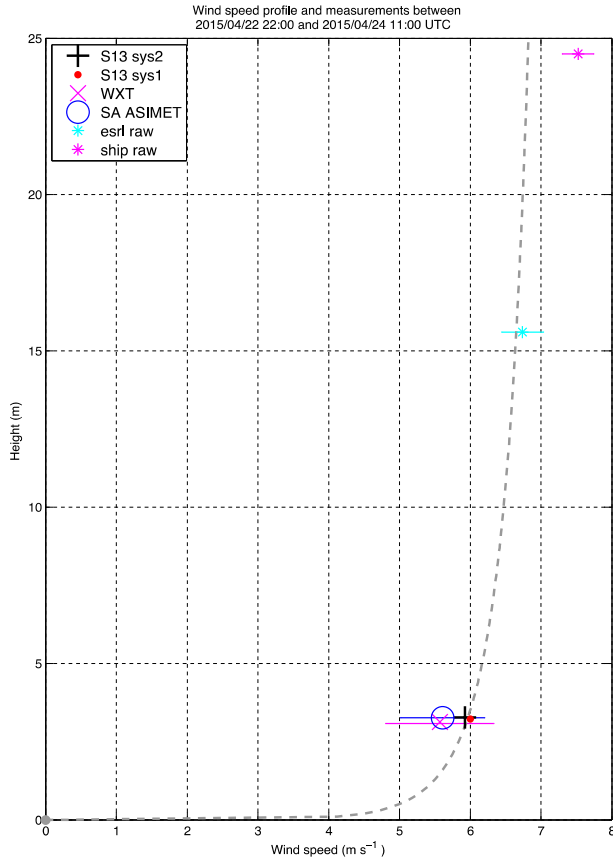
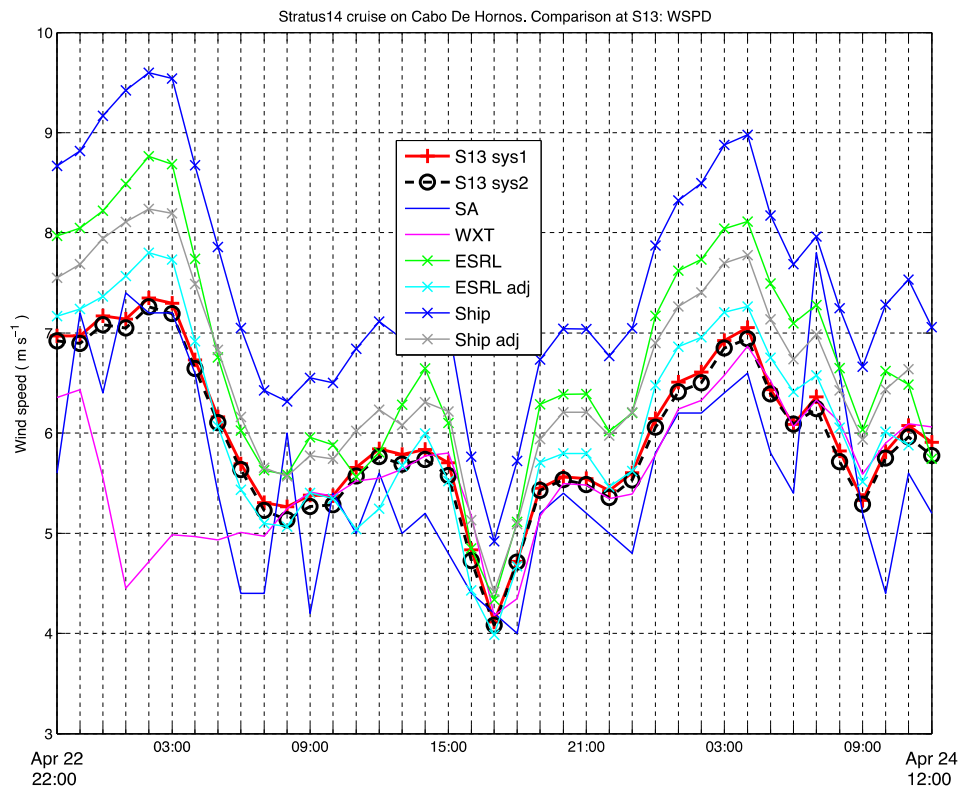

Figure 4-5 (left). As in Figure 4-1 but for wind speed.

Figure 4-6 (below). As in Figure 4-2 but for wind speed.



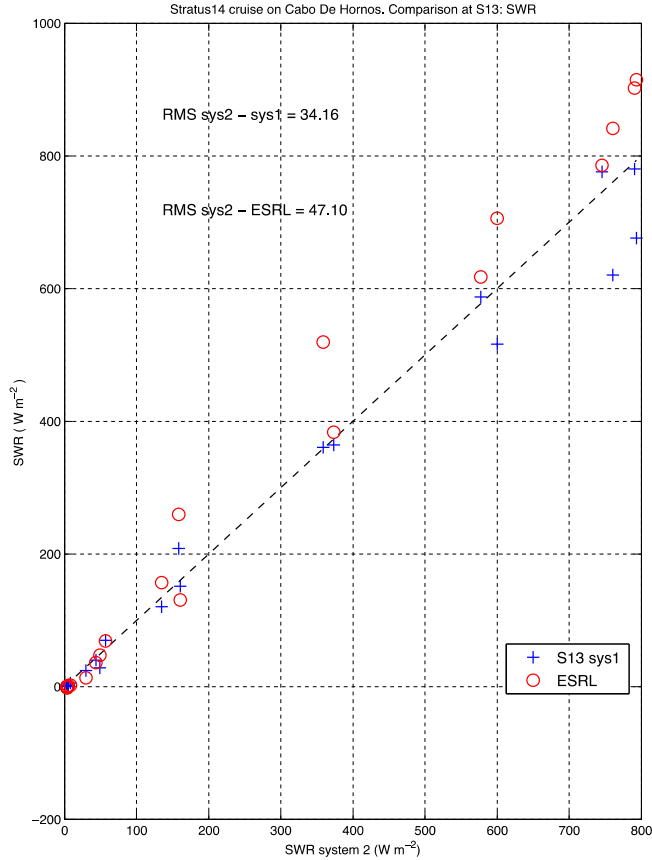
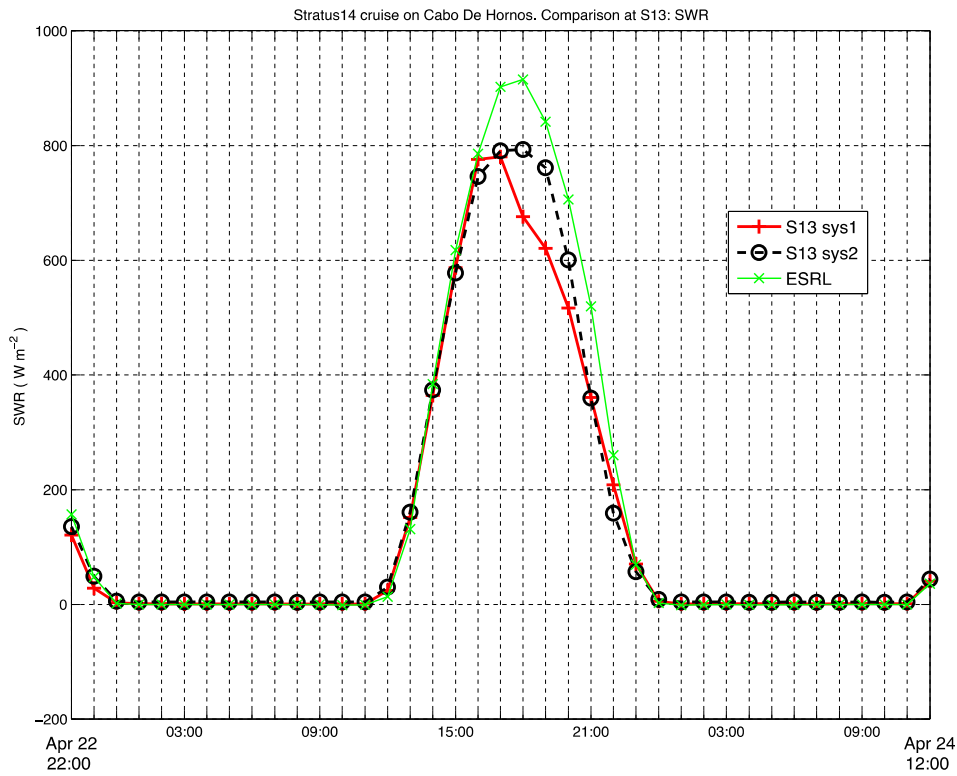

Figure 4-7 (left). Scatter plot of SWR difference between system 2 on Stratus 13 and other sensors, during inter-comparison.

Figure 4-8 (below). Time-series of SWR from buoy and ESRL during inter-comparison at Stratus 13 buoy.



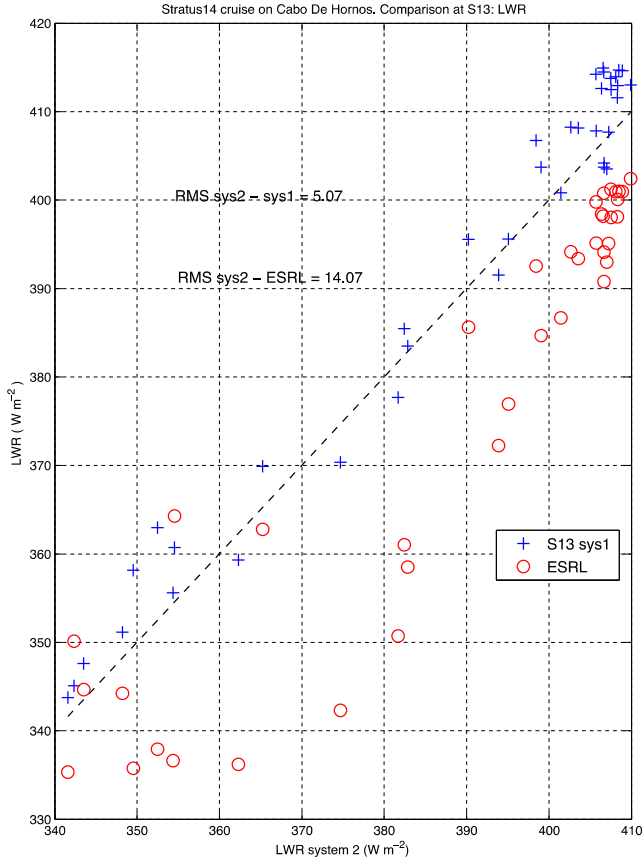
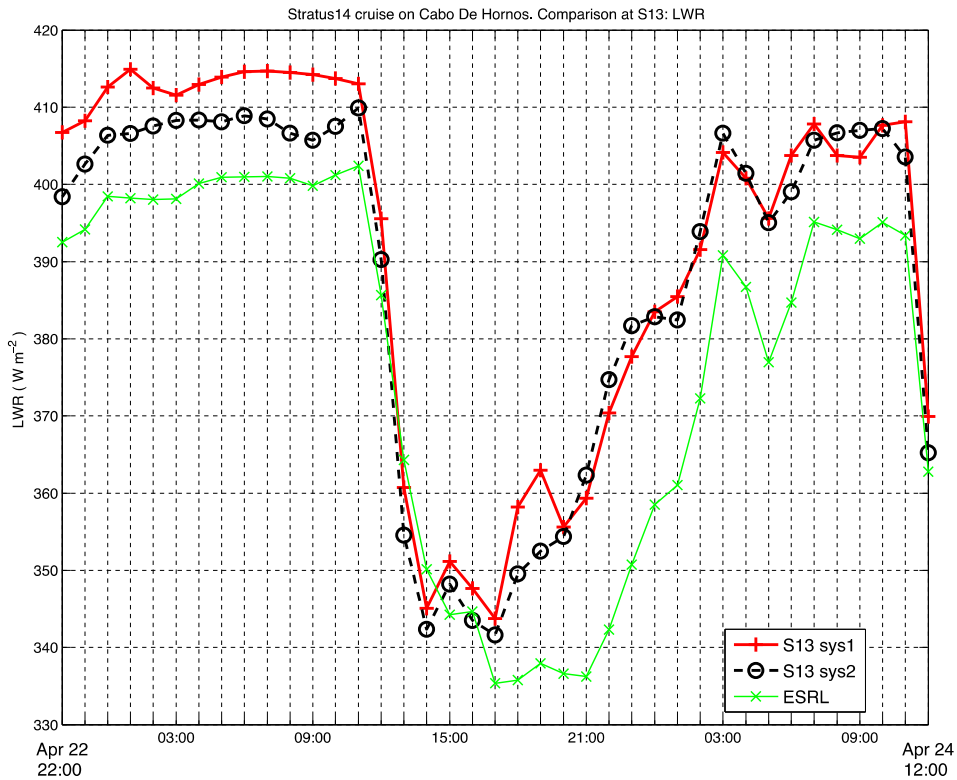

Figure 4-9 (left). Scatter plot of LWR difference between system 2 on Stratus 13 and other sensors, during inter-comparison.

Figure 4-10 (below). Time-series of LWR from buoy and ESRL during inter-comparison at Stratus 13 buoy.



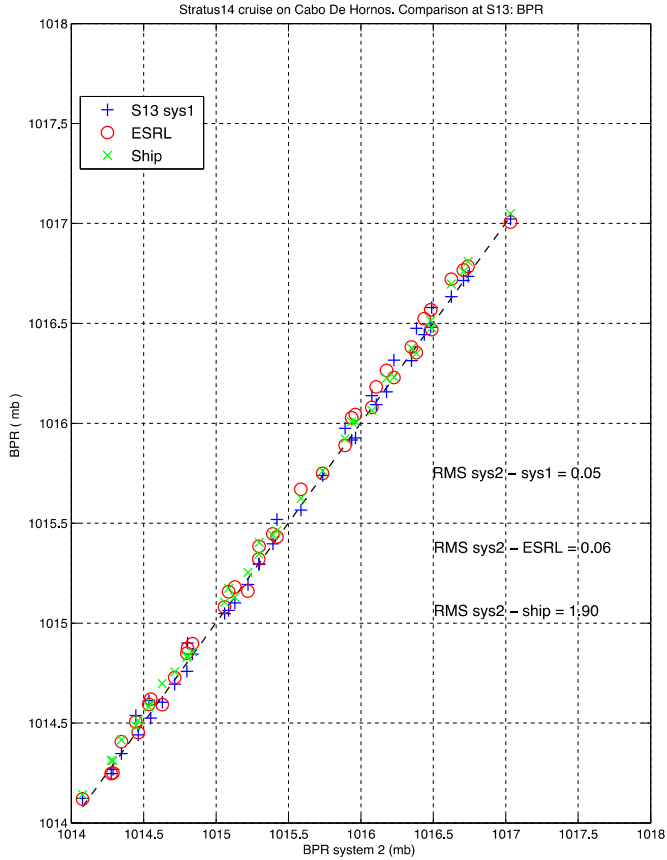
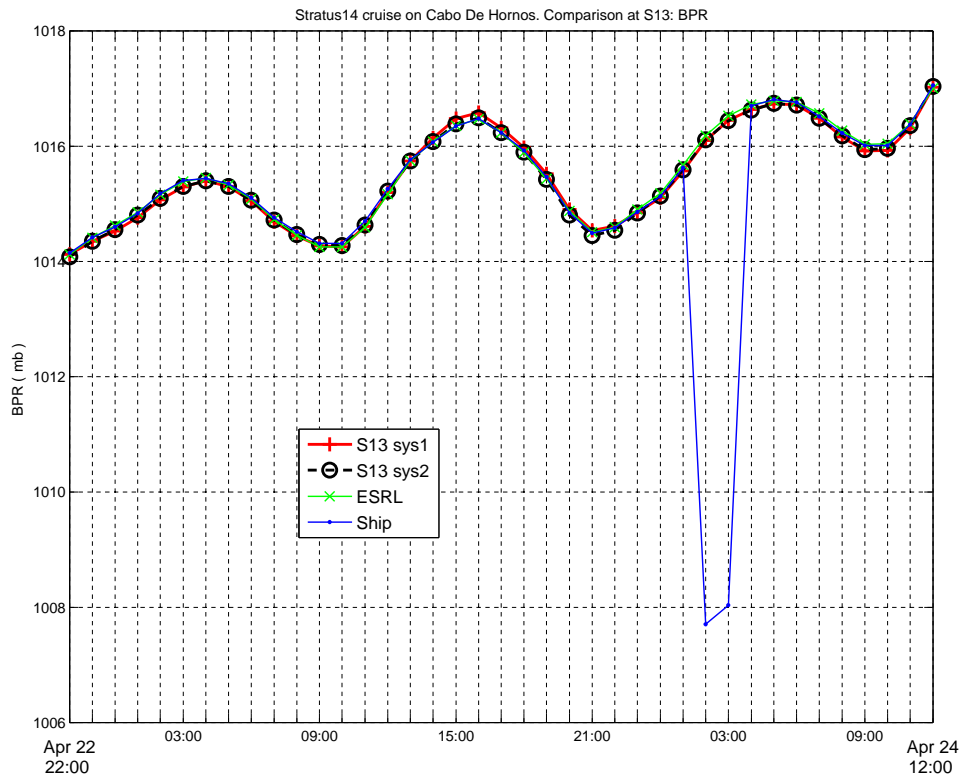

Figure 4-11 (left). Scatter plot of BPR difference between system 2 on Stratus 13 and other sensors, during inter-comparison.

Figure 4-12 (below). Time-series of BPR from buoy and ESRL during inter-comparison at Stratus 13 buoy.



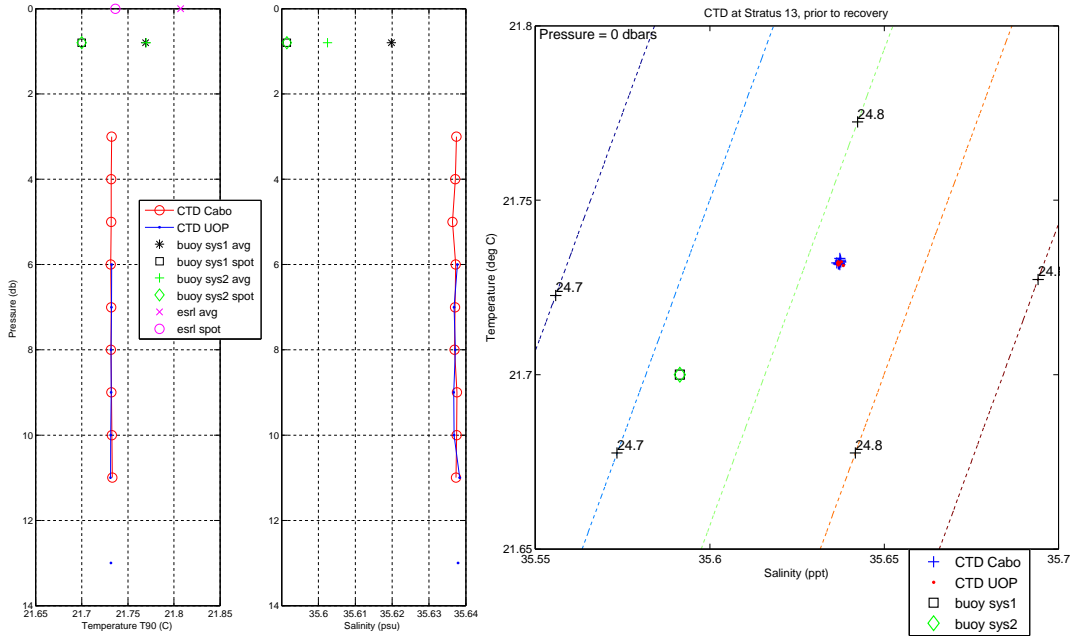

Figure 4-13. Comparison between CTD cast and data from nearby Stratus 13. Left panel: profiles of temperature (left) and salinity (center) for upper 10 m of CTD cast; symbols at surface denote buoy data (black, green) and ESRL (magenta). Right panel: same data shown as T-S plot. Two CTD instruments were used, one from the UOP group (blue) and one from the ship *Cabo de Hornos* (red).

C. Inter-comparison: Stratus 14 vs Stratus 13 buoy

Since Stratus 14 was deployed before Stratus 13 was recovered, both buoys were simultaneously in the water for about 2.5 days. We looked at the data from both buoys from April 21 2100 UTC (1 hour after anchor drop) to April 24 1200 UTC (slightly after mooring release). Figures C.1 to C.1 show the comparisons between the two primary ASIMET systems on both buoys. Some of the differences probably come from the spatial separation between the two buoys (about 16 nm). However, some biases are consistent with the inter-comparison with ship’s measurements that were described in the previous section. Note that data from Stratus 14 is telemetered and has noticeably lower resolution for some variables (conductivity, barometric pressure).

Air temperature measurements from each ASIMET system on both buoys are consistent with each other. No noticeable difference is seen between the two buoys (Fig. 4-14). HRH from system 2 on stratus 13 is similar to measurements from Stratus 14 sensors during the second part of the inter-comparison and possibly lower during the first part (Fig. 4-15). However, HRH from Stratus 13 system 1 is consistently lower than any other measurement (about 2.5 %RH lower than Stratus 13 system 2). Wind speed looks good in Fig. 4-16. Wind direction shows a 6° difference between ASIMET sensors on Stratus 14 (Fig. 4-17). But it is reassuring that these measurements bracket the ones from ASIMET sensors on Stratus 13, which are right on top of each other. The offset on Stratus 14 may

be due to the actual precision of the compass and vane reading of the sensor. It is not clear if resolution of Argos data could also be a factor. Shortwave radiation on Stratus 13 was much lower than Stratus 14 on the second part of the inter-comparison, which was sunny according to the SWR time-series in Fig. 4-18. The order of magnitude for this low bias for Stratus 13 SWR ($\sim 100 \text{ W m}^{-2}$) is in keeping with the comparison with ESRL data in the previous section. Stratus 13 SWR sensors will need to be post-calibrated in order to check if the low bias is caused by bird droppings or actual sensor bias. Longwave radiation in Fig. 4-19 looks ok but it is possible that LWR from Stratus 13 is a bit high ($\sim 10 \text{ W m}^{-2}$) compared to Stratus 14. Barometric pressure shown in Fig. 4-20 looks good, although poor resolution in Argos (BPR is stored as lower integer) prevents an accurate evaluation. SST in Fig. 4-21 looks good and the difference between the two buoys is to be expected due to the spatial separation between the buoys. Surface conductivity in Fig. 4-22 confirms that system 2 on Stratus 13 is low. The low bias shown here is 0.002 S m^{-1} compared to system 1. Poor resolution in Argos data from Stratus 14 (0.01 S m^{-1}) prevents any useful comparison. Precipitation data is shown in Fig. 4-23. Stratus 14 measurements both show a small rain event in the morning of April 22. System 1 on Stratus 13 also shows data consistent with rain around that time; however, rain events in the area are usually very localized so any comparison between the two buoys is hazardous. As mentioned in the cruise timeline (see beginning of this cruise report), there were patchy rain events observed from the ship on April 21 and 22.

The biases identified here will need to be confirmed with post-cruise calibrations. Depending on these calibrations, the nature of the biases could be identified as sensor or environmental biases. Examples of the first kind of bias are aging of the paint on the domes of radiation sensors, electronic drift, etc. Environmental biases can be bird droppings on radiation sensors, barnacles' growth on conductivity sensors, etc. The distinction is important, as any correction of the data in post-processing would depend on the nature of the bias (e.g. correcting for linear drift versus substituting with second sensor when low SWR appear).

Figure 4-24 shows a picture of Stratus 13 right after recovery. The aft SWR sensor has bird dropping on its dome.

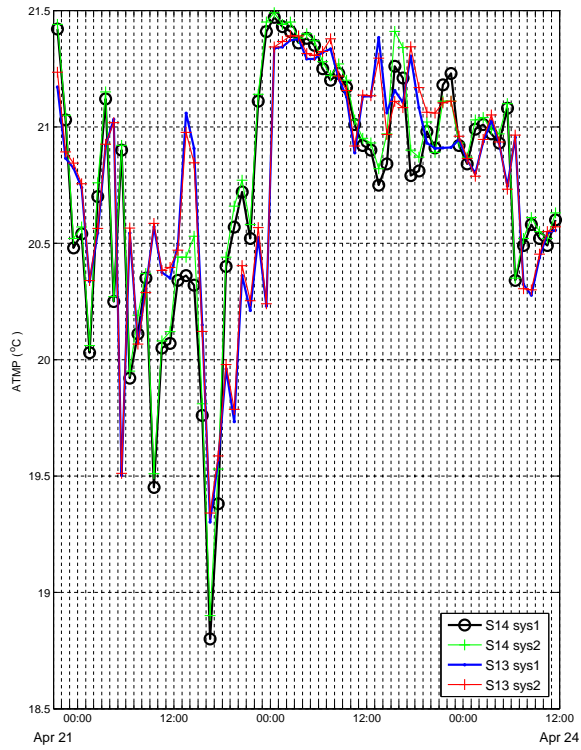

Figure 4-14. ATMP from two primary ASIMET on Stratus 13 and 14 while both buoys were deployed.

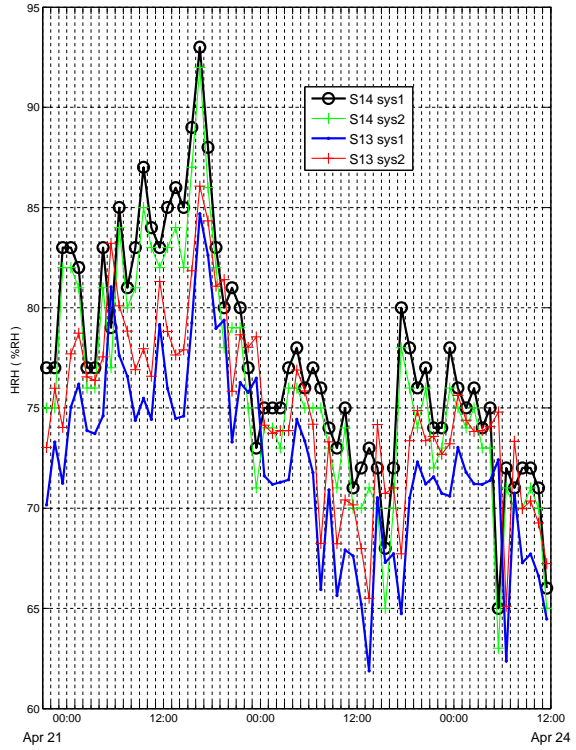

Figure 4-15. Same as Fig. 4-14 but for HRH.

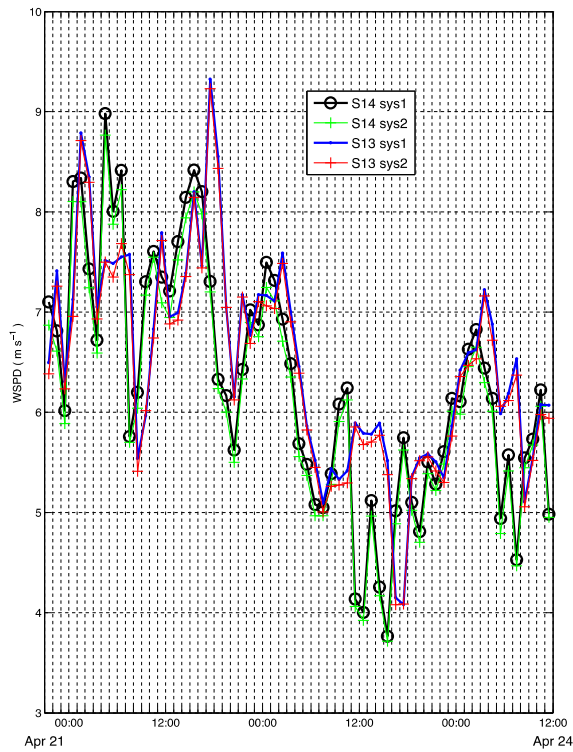

Figure 4-16. Same as Fig. 4-14 but for WSPD

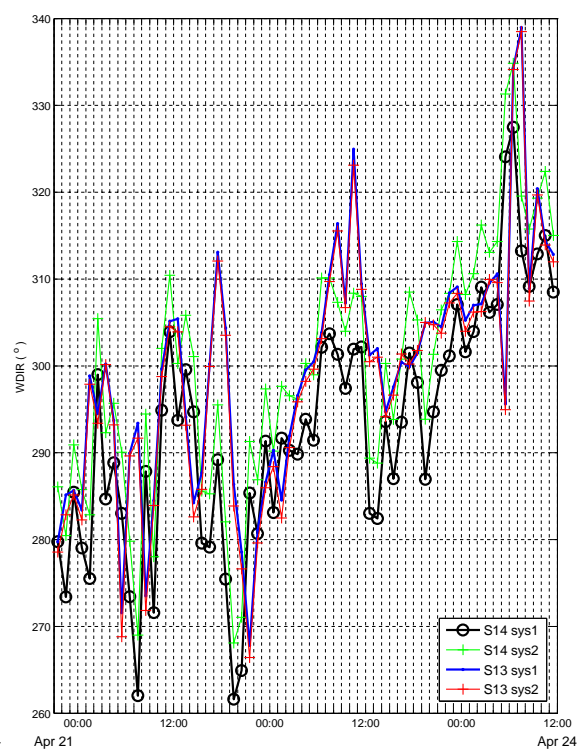

Figure 4-17. Same as Fig. 4-14 but for WDIR.

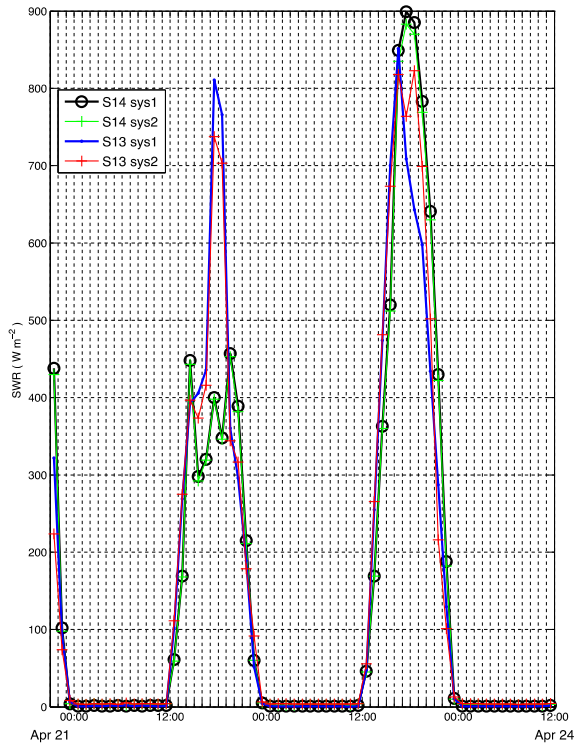

Figure 4-18. Same as Fig. 4-14 but for SWR.

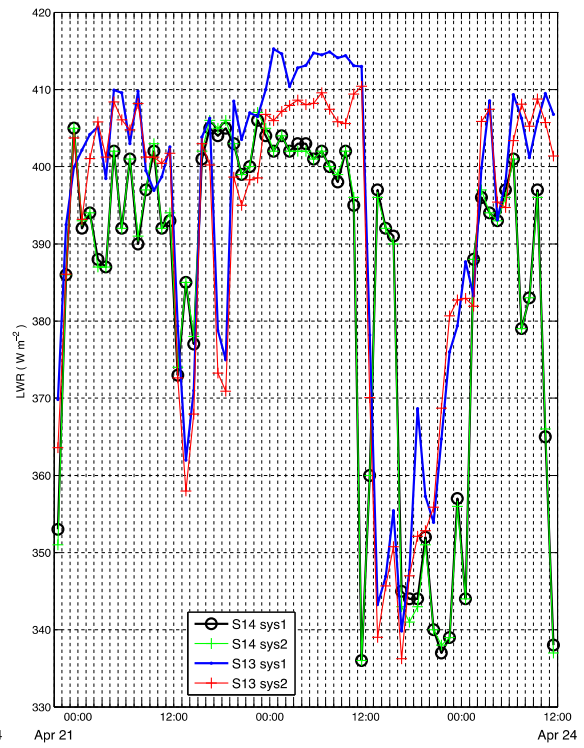

Figure 4-19. Same as Fig. 4-14 but for LWR.

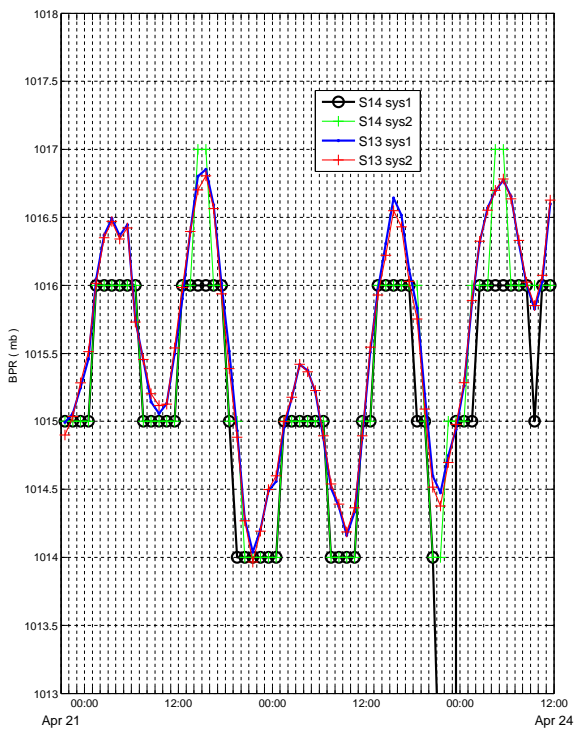

Figure 4-20. Same as Fig. 4-14 but for BPR.

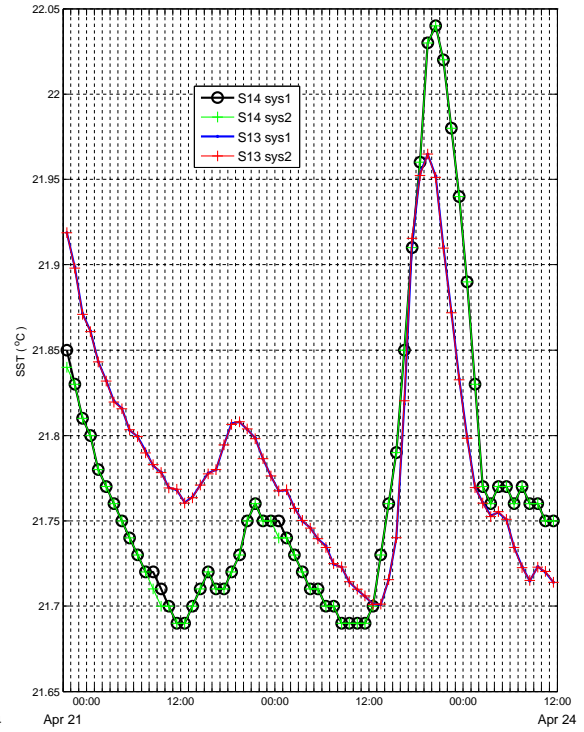

Figure 4-21. Same as Fig. 4-14 but for SST.

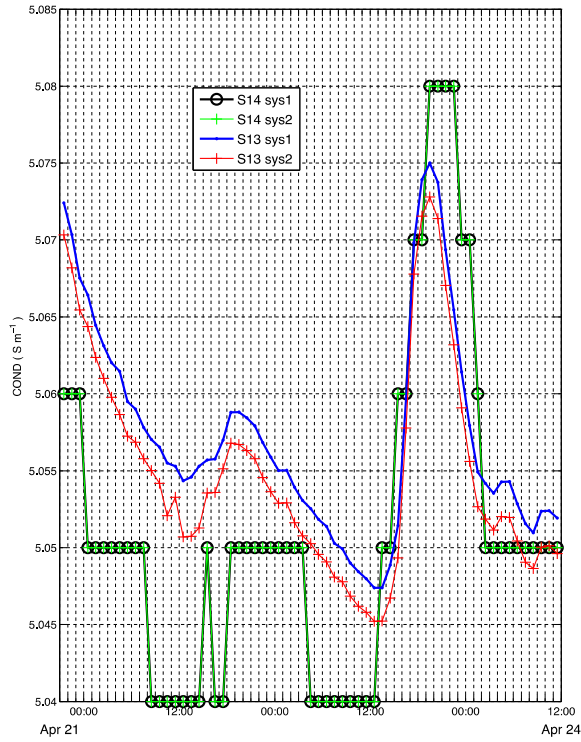

Figure 4-22. Same as Fig. 4-14 but for COND.

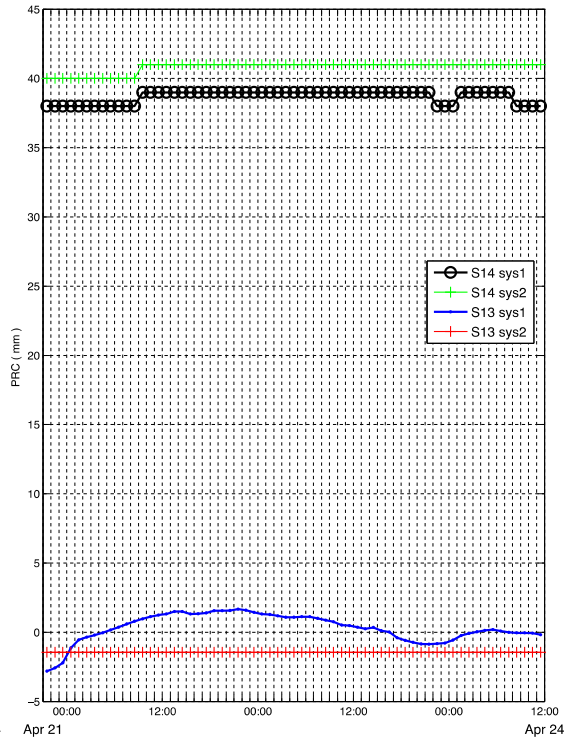

Figure 4-23. Same as Fig. 4-14 but for PRC.



Figure 4-24. Picture of Stratus 13 buoy after recovery (IMG_1484.JPG). Note dropping on aft SWR.

D. Data Return from Stratus 13

Preliminary data processing from Stratus 13 instrumentation was done at sea and is described below.

1) ASIMET Instrumentation

Binary data files from loggers were copied from flash memory using a Linux PC, and were converted to Matlab with a specialized conversion program, `imet_bin_prob.m` version 20130116, because of issues with the binary files; this code handles faulty records on CF data files. Data from all the modules' CF cards was copied using a standard 'drag and drop' card reader, and was converted to Matlab using `load_bin_module.m` version 2010/10/21. The stand-alone modules and some other interesting sensors were over-plotted with one or more logger records, others were just processed for completeness. Data return tables in this section are based solely on the number of records recorded during the deployed period of the mooring (07-Mar-2014 18:01:01 to 24-Apr-2015 11:34:01; duration is 594333 minutes).

Table 4-1: Stratus 13 ASIMet Logger data return.

SN	first	last	#points	#expt	%return
4	07-Mar-2014 18:02	24-Apr-2015 11:34	594333	594333	100
14	07-Mar-2014 18:02	24-Apr-2015 11:34	594333	594333	100

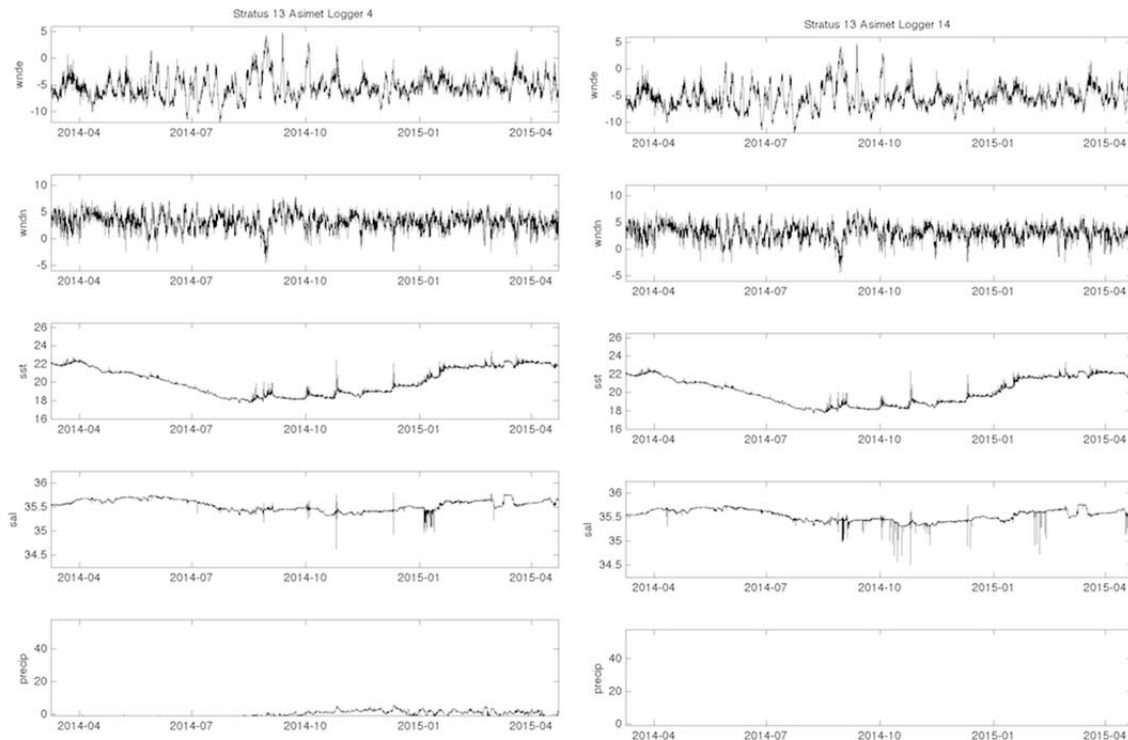

Figure 4-25: Data return from loggers (logger 4 on left, logger 14 on right) on Stratus 13, from top to bottom: wind east, wind north, sst, salinity, precipitation.

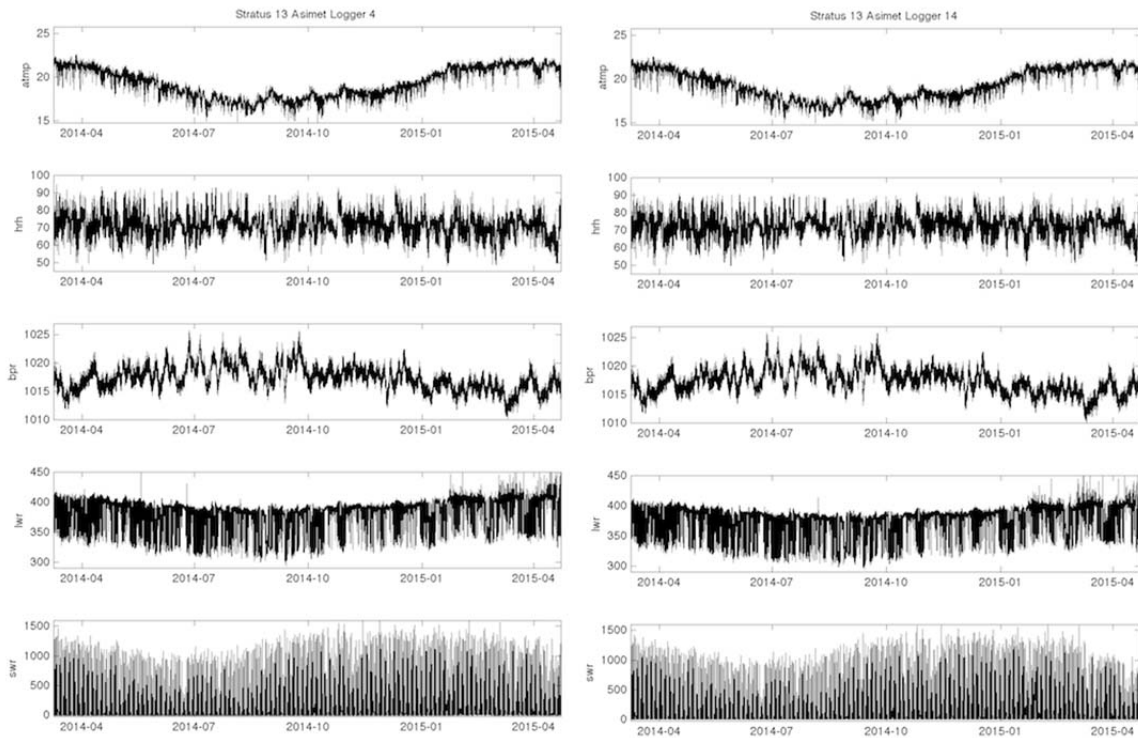

Figure 4-26: Same as Fig. 1 but for ATMP, HRH, BPR, LWR, SWR (top to bottom).

2) Lascar EL-USB-2+

File Stratus13.txt was slightly different format from other EL-USB units, converted to Matlab with local copy of loadlascar.m, overplotted with System 1 and Sensirion stand-alone module. Note this is a ‘EL-USB-2+’ which has somewhat better resolution/accuracy than the earlier ‘EL-USB-2’ model.

Table 4-2: Stratus 13 EL-USB-2+ data return.

SN	first	last	#points	#expt	rate	%return
243	07-Mar-2014 19:00	24-Apr-2015 11:00	9905	9905	60	100

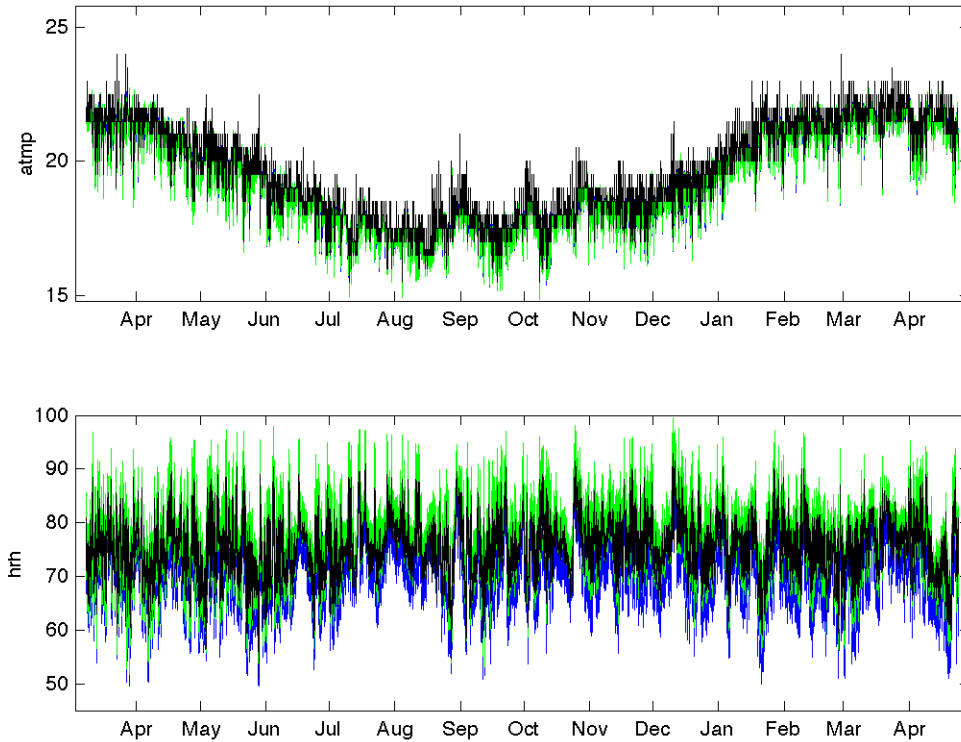

Figure 4-27: Stratus 13 data return: Lascar (black), Logger 4 (blue), Sensirion 247 (green). Top: ATMP, bottom: HRH.

3) Nortek 2 MHZ profiler SN 357 at 10m

Data was not dumped at sea because cable and connector were unavailable. Data was extracted and processed after the instrument was shipped back to Woods Hole, in June 2015. cursory look at the data (Fig. 4-28) shows the return signal amplitude decreased sharply in July 2014 for beams 1 and 2.

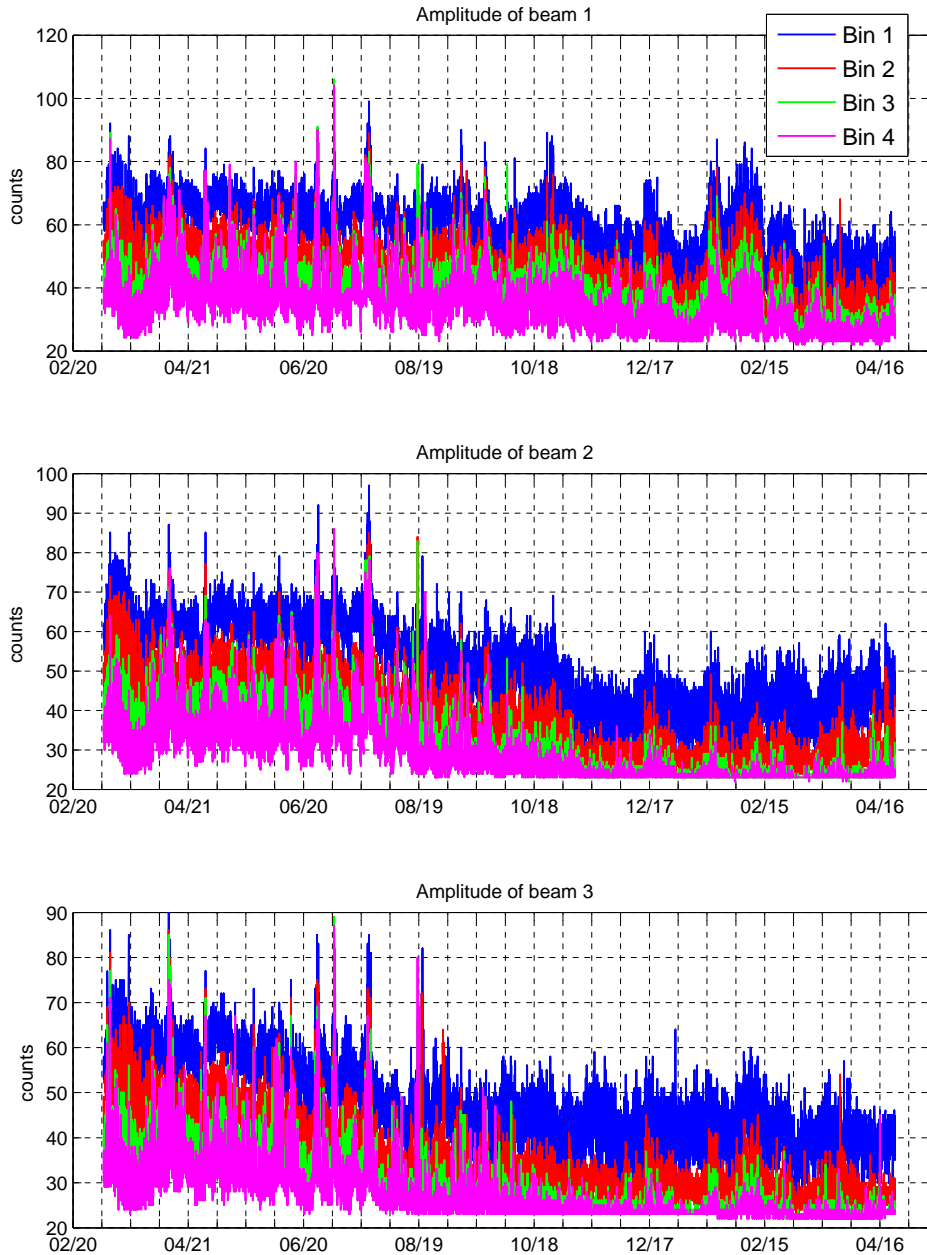

Figure 4-28. Stratus 13 Nortek profiler SN 357. Amplitude from return signal for all three beams and first 4 bins.

4) Aanderaa RCM11

Data was dumped from instruments as packed binary and translated to 'raw ascii, engineering units' using Aanderaa's '5059' program. However, we could not confirm that the calibration and configuration files (e.g. 'RCM11 sn 79 cdb.cdb') were properly loaded into 5059, so data should be considered preliminary. Data was translated into Matlab after removing the '+' signs with shell utility 'awk'. Program dorcm11s.m

generated a date field, but did not have positive ID on the columns, which were left as a big array. Note that SN 79 had clock issues (might need to re-dump).

Table 4-3: Stratus 13 RCM11 data return.

SN	first	last	#points	#expt
13	07-Mar-2014 18:10	24-Apr-2015 11:22	19811	20225
78	07-Mar-2014 18:02	24-Apr-2015 11:34	19811	20225
79	07-Mar-2014 18:10	24-Apr-2015 11:15	9905	20225

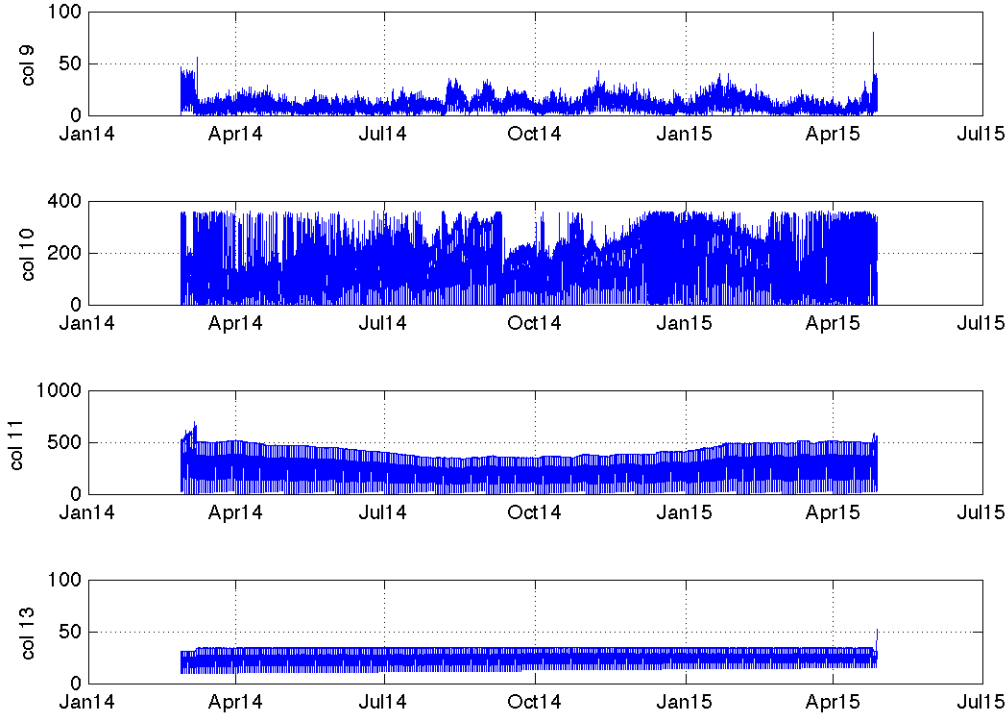

Figure 4-29: Stratus 13 data return: RCM11 SN 79 overview of raw column data.

5) RDI Workhorse ADCP 300KHZ

Generated Matlab file S13RDI_1218_raw.mat from binary file STR13000.000 using the standard upkadc.m, and converted into a more standard UOP Matlab file, s13_rdi_1218.mat, using script do_adcp.m.

Table 4-4: Stratus 13 RDI ADCP data return.

SN	first	last	#points	#expt	%return
1218	07-Mar-2014 19:00	24-Apr-2015 11:00	9905	9905	100

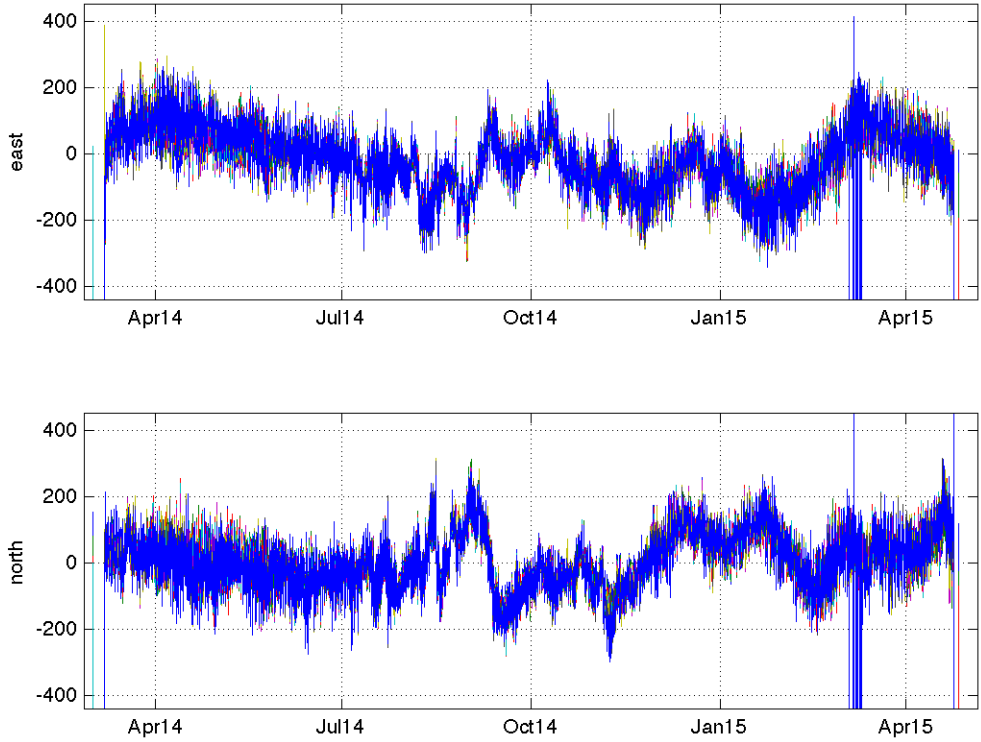

Figure 4-30: Stratus 13 current (mm s^{-1}) from RDI #1218. Top: east, bottom: north. All bins are super-imposed.

6) SBE 16

Hex files converted with SBEDataProcessing on a PC after editing the xmlcon files to include the correct pressure, 4580.19 and sample rate, 1800 seconds. Converted to Matlab using script getsbe16.m, version 2012/12/12.

Table 4-5: Stratus 13 SBE16 data return.

SN	first	last	#points	#expt	rate	%return
1873	07-Mar-2014 18:30	24-Apr-2015 11:30	19811	19811	30	100
1875	07-Mar-2014 18:30	24-Apr-2015 11:30	19811	19811	30	100

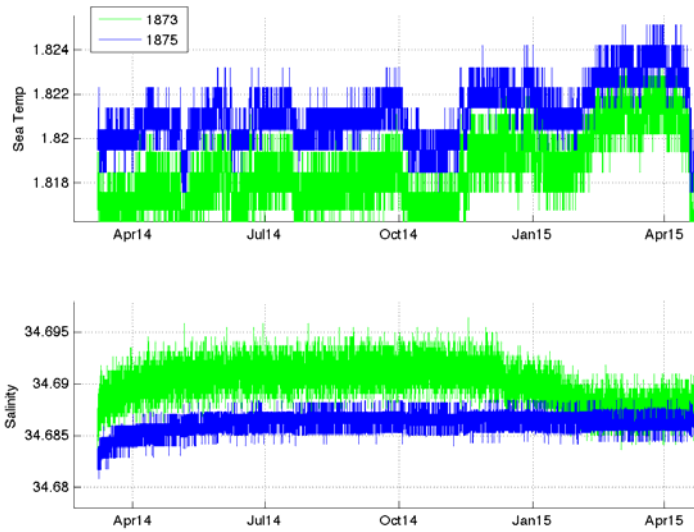

Figure 4-31: Stratus 13 data return from SBE 16s. Top: temperature, bottom: salinity.

7) SBE 37

We did not dump internally-recorded data from SSTs. Data from other units were converted to Matlab and plotted. Some issues with units at 85 and 160 m (SNs 1909 and 8212). SN 1909 ends early. Sensors listed in Table 4-6 all recorded at 5 minutes.

Table 4-6: Stratus 13 SBE37 data return.

SN	first	last	#points	#expt	%return
1325	07-Mar-2014 18:05:02	24-Apr-2015 11:30:02	118866	118866	100.00
1326	07-Mar-2014 18:05:00	24-Apr-2015 11:30:00	118866	118866	100.00
1328	07-Mar-2014 18:05:02	24-Apr-2015 11:30:03	118866	118866	100.00
1329	07-Mar-2014 18:05:00	24-Apr-2015 11:30:01	118866	118866	100.00
1330	07-Mar-2014 18:05:01	24-Apr-2015 11:30:00	118866	118866	100.00
1906	07-Mar-2014 18:05:01	24-Apr-2015 11:30:02	118866	118866	100.00
1908	07-Mar-2014 18:05:02	24-Apr-2015 11:30:01	118866	118866	100.00
1909	07-Mar-2014 18:05:01	16-Sep-2014 21:20:01	55624	118866	46.80
3733	07-Mar-2014 18:05:01	24-Apr-2015 11:30:02	118866	118866	100.00
8211	07-Mar-2014 18:05:01	24-Apr-2015 11:30:00	118866	118874	99.99
8212	07-Mar-2014 18:05:01	24-Apr-2015 11:30:00	118866	118874	99.99
8215	07-Mar-2014 18:05:01	24-Apr-2015 11:30:00	118866	118874	99.99
8216	07-Mar-2014 18:05:01	24-Apr-2015 11:30:00	118866	118874	99.99
8217	07-Mar-2014 18:05:01	24-Apr-2015 11:30:00	118866	118874	99.99
8218	07-Mar-2014 18:05:01	24-Apr-2015 11:30:00	118866	118874	99.99
8219	07-Mar-2014 18:05:01	24-Apr-2015 11:30:00	118866	118874	99.99
8220	07-Mar-2014 18:05:01	24-Apr-2015 11:30:00	118866	118874	99.99
8221	07-Mar-2014 18:05:01	24-Apr-2015 11:30:00	118866	118874	99.99
8224	07-Mar-2014 18:05:01	24-Apr-2015 11:30:00	118866	118874	99.99
8225	07-Mar-2014 18:05:01	24-Apr-2015 11:30:00	118866	118874	99.99

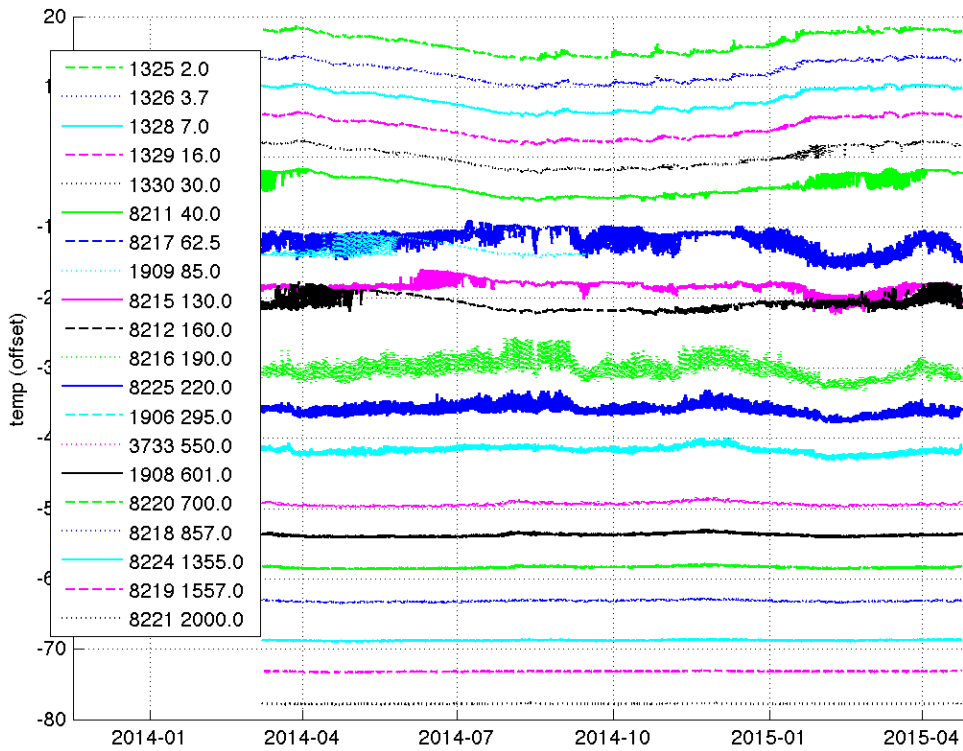

Figure 4-32: Stratus 13 data return from SBE 37s: temperature.

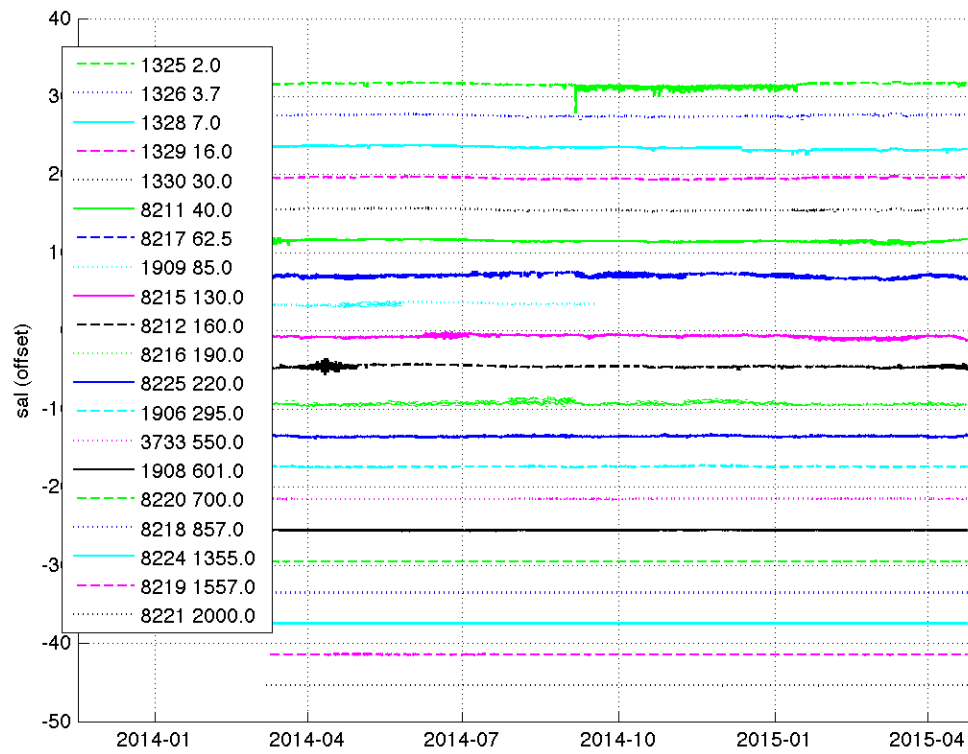

Figure 4-33: Stratus 13 data return from SBE 37s: salinity.

8) SBE 39s

The .asc files were converted to Matlab and plotted. SN 102 at 70m and SN 103 at 78m failed early, in late October 2014. SN 720 at 280m failed shortly before recovery. The SBE39s all recorded at 5 minutes.

Table 4-7: Stratus 13 SBE39 data return.

SN	first	last	#points	#expt	%return
1447 AT	07-Mar-2014 18:05:00	24-Apr-2015 11:30:08	118866	118866	100
0035	07-Mar-2014 18:05:00	24-Apr-2015 11:30:00	118866	118866	100
0038	07-Mar-2014 18:05:00	24-Apr-2015 11:30:00	118866	118866	100
0044	07-Mar-2014 18:05:00	24-Apr-2015 11:29:59	118866	118866	100
0048	07-Mar-2014 18:05:00	24-Apr-2015 11:29:59	118866	118866	100
0049	07-Mar-2014 18:05:00	24-Apr-2015 11:29:59	118866	118866	100
0102	07-Mar-2014 18:05:00	30-Nov-2014 13:39:59	77132	118866	64.89
0103	07-Mar-2014 18:05:00	19-Sep-2014 19:04:59	56461	118866	47.50
0203	07-Mar-2014 18:05:00	24-Apr-2015 11:30:00	118866	118866	100
0276	07-Mar-2014 18:05:00	24-Apr-2015 11:30:00	118866	118866	100
0284	07-Mar-2014 18:05:00	24-Apr-2015 11:29:59	118866	118866	100
0719	07-Mar-2014 18:05:00	24-Apr-2015 11:29:59	118866	118866	100
0720	07-Mar-2014 18:05:00	11-Mar-2015 23:55:00	106343	118866	89.46

9) SBE 56s

One SN was incorrectly recorded in the deployment excel file and on the mooring log; SN 2064 was not deployed, and 2068 was in its place. All ran, all converted to Matlab, plotted.

Table 4-8: Stratus 13 SBE56 data return.

SN	first	last	#points	#expt	%ret
2065	07-Mar-2014 18:02:00	24-Apr-2015 11:33:59	594333	594332	100
2066	07-Mar-2014 18:01:58	24-Apr-2015 11:33:59	594333	594332	100
2067	07-Mar-2014 18:01:58	24-Apr-2015 11:33:59	594333	594332	100
2068	07-Mar-2014 18:01:58	24-Apr-2015 11:33:59	594333	594332	100

10) Aanderaa Seaguard

Converted to matlab, using structs. Module SNs are in meta.instrument.sensors. All recorded at 30 minute rate.

Table 4-9: Stratus 13 Aanderaa Seaguard data return.

SN	First	Last	#points	Other records
138	26-Feb-2014 18: 30: 01	25-Apr-2015 17: 30: 00	20303	O2: 1088
140	26-Feb-2014 18: 30: 01	22-Aug-2014 15: 00: 01	8490	O2: 1088
141	26-Feb-2014 18: 30: 01	27-Apr-2015 00: 00: 01	20364	O2: 1088
142	26-Feb-2014 18: 30: 01	26-Apr-2015 22: 30: 01	20361	O2: 1088
143	26-Feb-2014 18: 30: 01	25-Apr-2015 22: 00: 02	20312	O2: 1088
144	26-Feb-2014 18: 30: 01	26-Apr-2015 22: 30: 01	20361	O2: 1088
181	26-Feb-2014 18: 29: 59	26-Apr-2015 20: 30: 00	20357	O2: 1088
182	26-Feb-2014 18: 30: 01	26-Apr-2015 19: 30: 01	20355	O2: 1088
961	26-Feb-2014 18: 29: 59	26-Apr-2015 22: 00: 00	20360	O2: 1088 Cond: 722 Pres: 473 Temp: 429
964	26-Feb-2014 18: 29: 59	25-Apr-2015 22: 30: 00	20313	O2: 1088 Cond: 722 Pres: 473 Temp: 429
969	26-Feb-2014 18: 29: 59	27-Apr-2015	20364	O2: 1088 Cond: 722 Pres: 473 Temp: 429

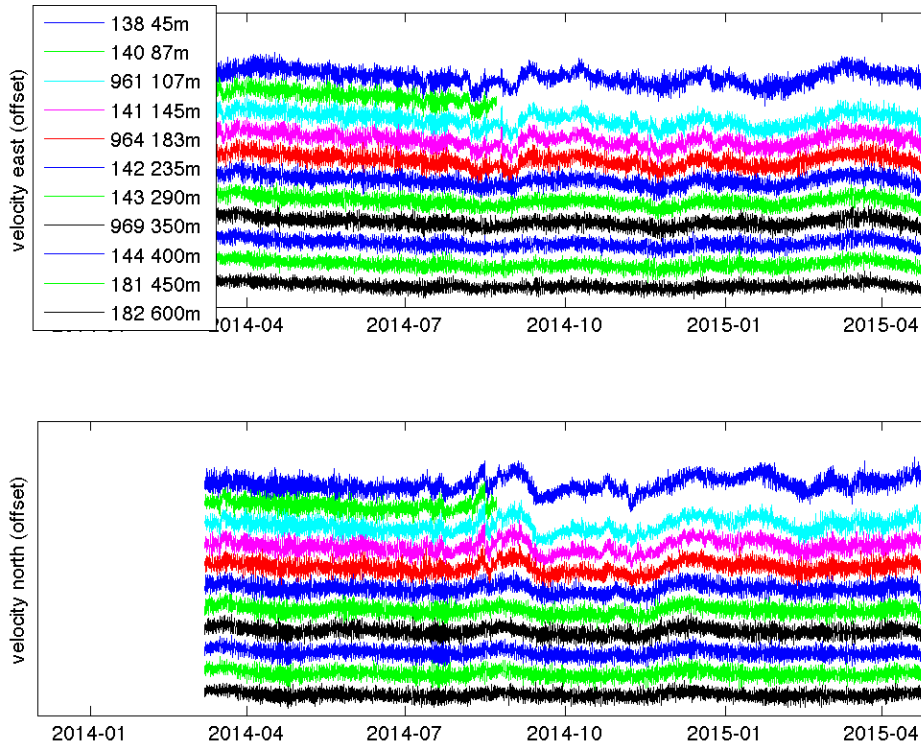

Figure 4-34: Stratus 13 currents from Aanderaa Seaguards. Top: east, bottom: north. Offset was added to each instrument for readability.

11) VMCM

Cards were read on Linux laptop, converted to Matlab with `get_vmcm.m` version 2012/5/30. Two units had full cards, two ended slightly early; two had noisy current direction values.

We thought the ‘compass on time’ might have been different for some of the VMCMs deployed, but the metadata in the capture files indicates that they were all set up the same way; the deployment capture text says ‘Compass Ontime=2 Offtime=13’ and the recovery capture text says ‘Compass Always On’ for all units.

Table 4-10: Stratus 13 VMCM data return.

SN	first	last	#points	#expt	%return
04	07-Mar-2014 18:01:30	24-Apr-2015 11:33:30	594333	594332	100.
31	07-Mar-2014 18:01:59	24-Apr-2015 11:33:59	594333	594332	100
32	07-Mar-2014 18:01:45	27-Mar-2015 03:52:45	553552	594332	93.14
42	07-Mar-2014 18:01:45	26-Feb-2015 01:29:45	511649	594332	86.09

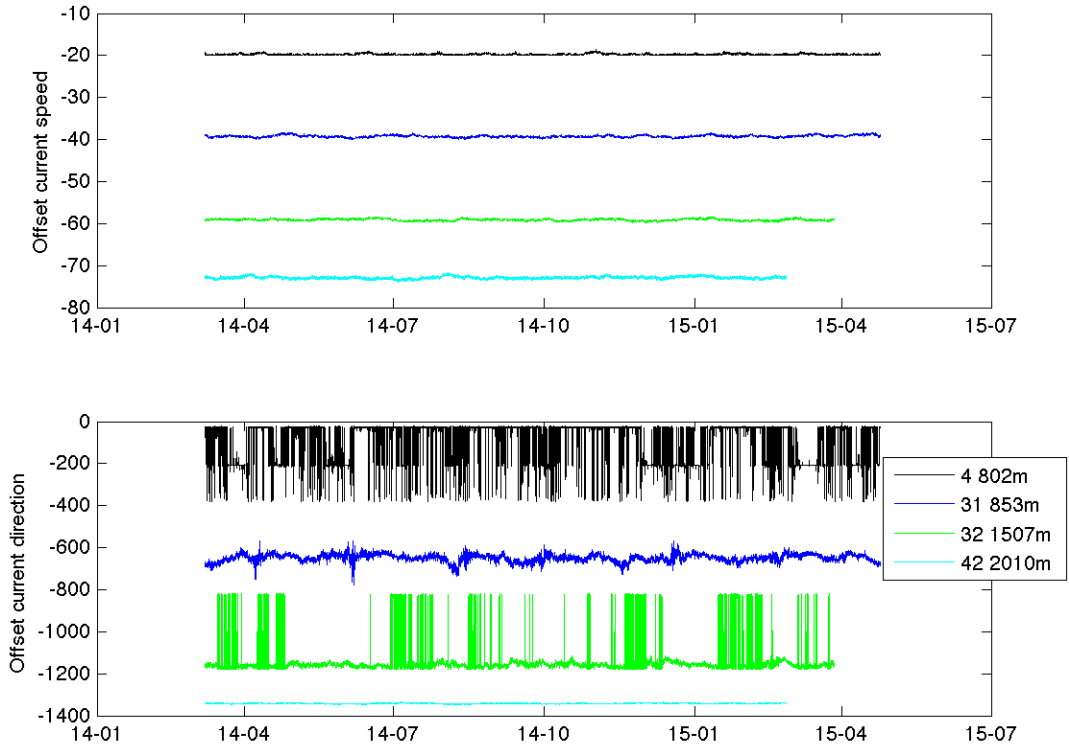

Figure 4-35: Stratus 13 currents from VMCMs. Top: speed, bottom: direction. Offset was added to each instrument for readability.

12) WXT520

This unit provided good data. Data was converted to Matlab using script load_wxt520.m, version 2014/03/05, and a slightly edited version was created (st13_wxt01C.mat) with some garbled records at the start and end of the file removed.

Table 4-11: Stratus 13 Vaisala WXT520 data return.

SN	first	last	#points	#expt	%return
01	07-Mar-2014 18:01:59	24-Apr-2015 11:33:59	594333	594332	100

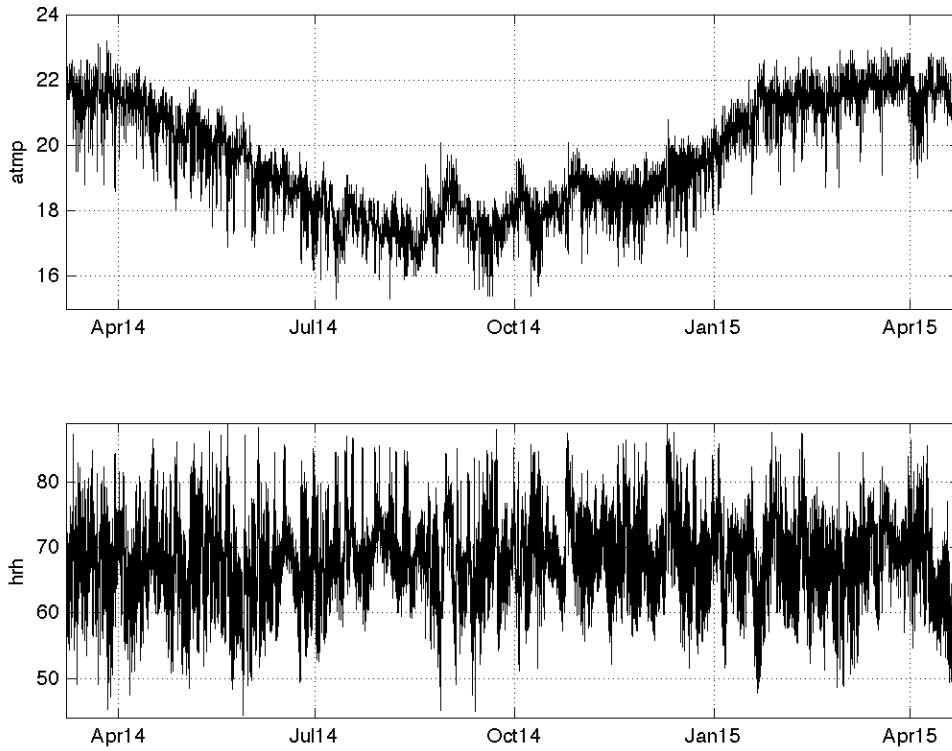

Figure 4-36: Stratus 13 data from Vaisala WXT520: air temperature (top) and relative humidity (bottom).

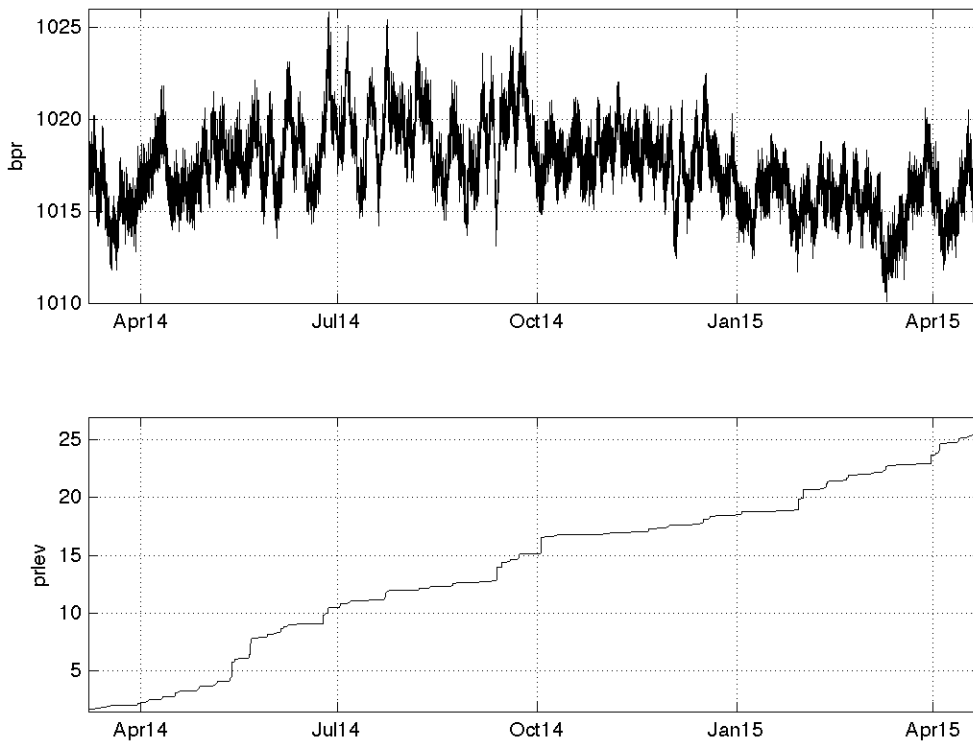

Figure 4-37: Stratus 13 data from Vaisala WXT520: barometric pressure (top) and precipitation (bottom).

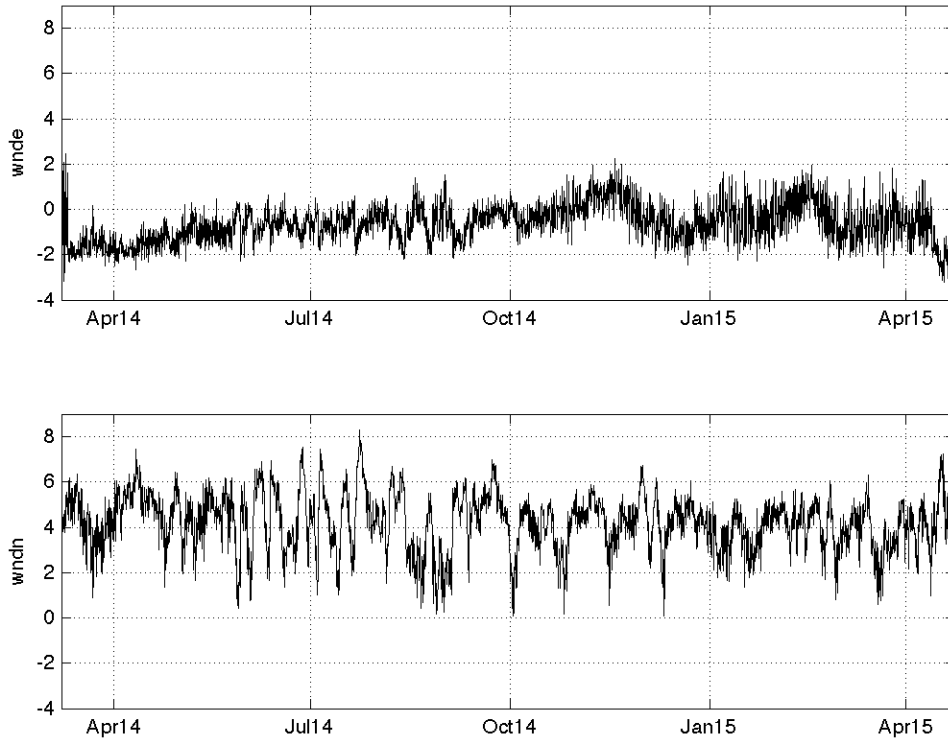

Figure 4-38: Stratus 13 data from Vaisala WXT520: wind east (top) and wind north (bottom).

13) Wetlabs Fluorometer

After returning to Woods Hole and receiving instrumentation back from shipment, further data processing took place. Chlorophyll data from fluorometer flsb-2866 was processed using `load_fluorometer.m` as explained in III.C.10, data from wetlabs fluorometer is converted from voltage counts to μg per liter using scale factor and dark counts values. These factors were respectively 0.0076 and 49 for FLSB-2866, as stipulated in either the characterization sheet provided by Wetlabs or in the `.dev` device file. According to data, every 100 minutes, this instrument sampled four times at one second intervals. Data file contains 24700 records from March 4 2014 10:00:20 UTC until April 28 2015 11:35:47 UTC.

Chlorophyll concentration during deployment varied between 0.2 and 1.5 $\mu\text{g l}^{-1}$; in April 2015 values were typically 0.5 $\mu\text{g l}^{-1}$ (Fig. 4-39). For comparison, similar data was extracted for the month of April, using the map viewer on the NASA website (http://neo.sci.gsfc.nasa.gov/view.php?datasetId=MY1DMM_CHLORA) and is shown in Fig. 4-40, with values near the Stratus mooring location between 0.1 and 1 mg m^{-3} (map and color legend (at the top) resolution make it difficult to bracket actual values precisely).

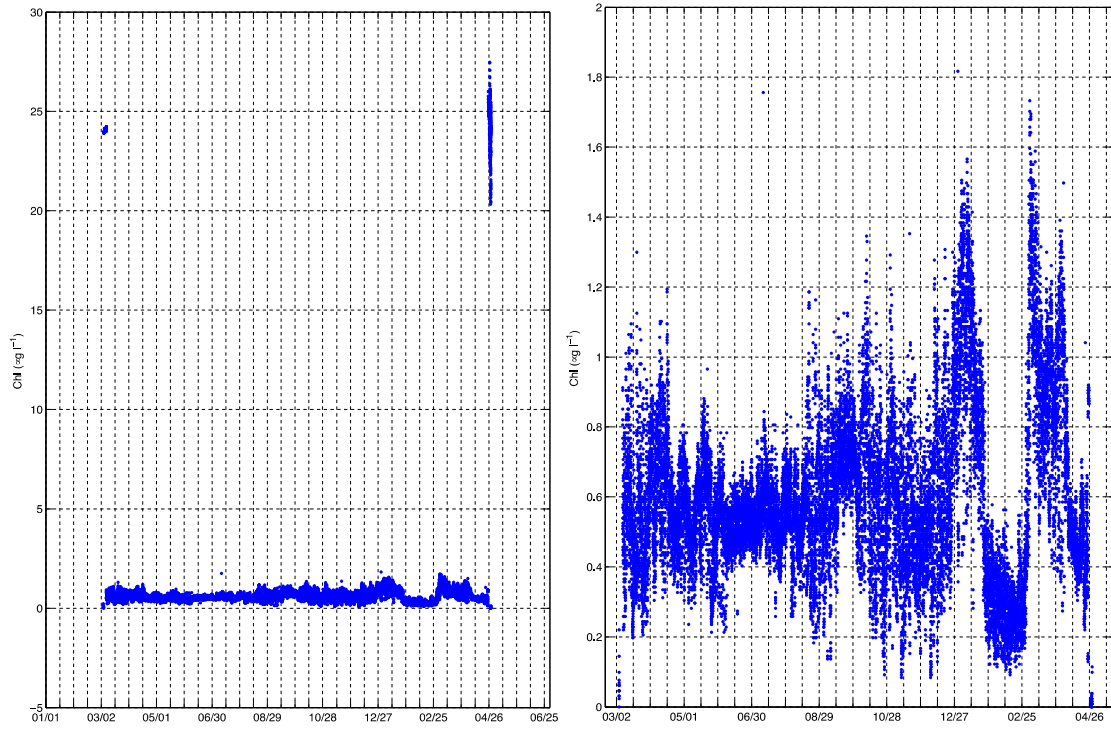

Figure 4-39. Stratus 13 chlorophyll concentration ($\mu\text{g l}^{-1}$) from Wetlabs fluorometer. Left: full record, right: zoom on actual deployment period.

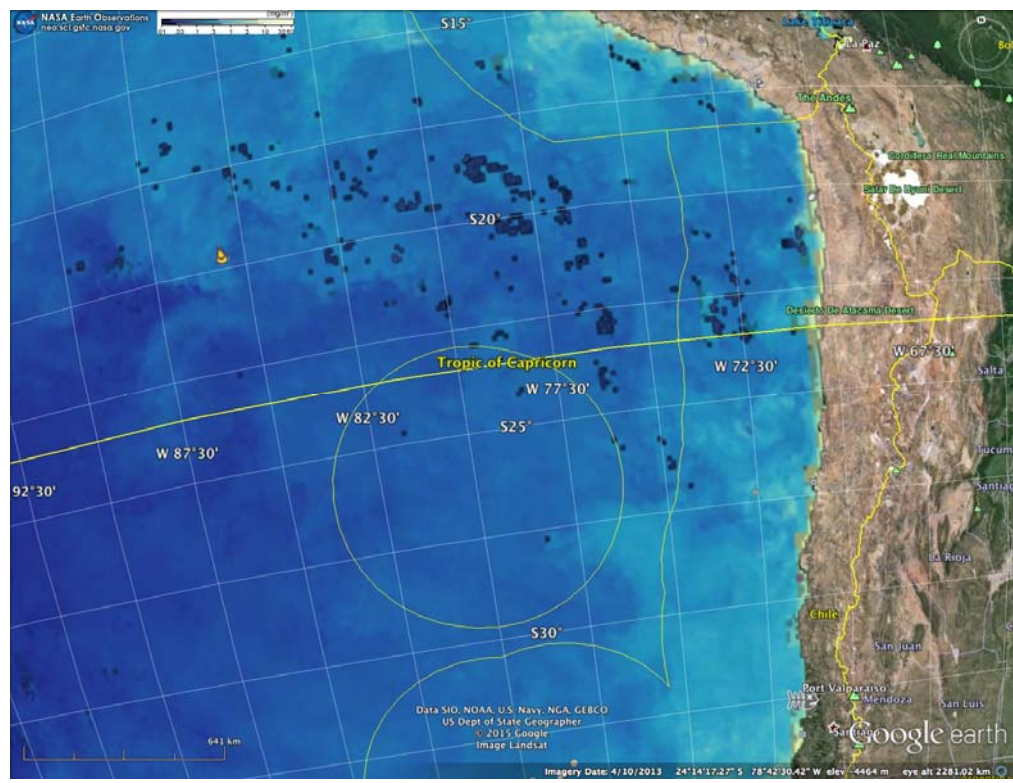

Figure 4-40: Chlorophyll content in April 2015 from Aqua/Modis.

V. Ancillary Projects

A. CTD Casts.

During the cruise we used two SBE 19 sensors for the CTD casts. The sensor from the *Cabo de Hornos* was calibrated in April 2010 and set to sample every 0.25 second while the UOP sensor was calibrated in June 2014 and set with 0.5 second sampling. On April 17, outside of the Chile EEZ, a CTD was done to 500 m depth in order to test the UOP SBE 19 sensor (along with acoustic releases). Data from that CTD had a gap between 100 m and 400 m, which was due to a problem with the magnetic Reed switch that turns on the pump and data collection of the instrument. On April 22, another CTD cast was done as part of the intercomparison of the newly deployed Stratus 14 mooring. For this cast, the two SBE 19 sensors (ship and UOP) were used. Unfortunately, the UOP sensor stopped working after 10 minutes, so only data from the ship's sensor is available and shown in Figures 5-1 to 5-3.

On April 23 13:00 UTC, a second CTD was done near the Stratus 13 mooring prior to its recovery. The magnetic Reed switch on the UOP SBE 19 sensor had previously been modified and the data collection operated normally. Figures 5-4 to 5-6 show the CTD data from the ship and UOP sensors. Note that the clock of the UOP SBE 19 is about 7 hours behind UTC according to headers in the data files and known upload times input by CTD operator.

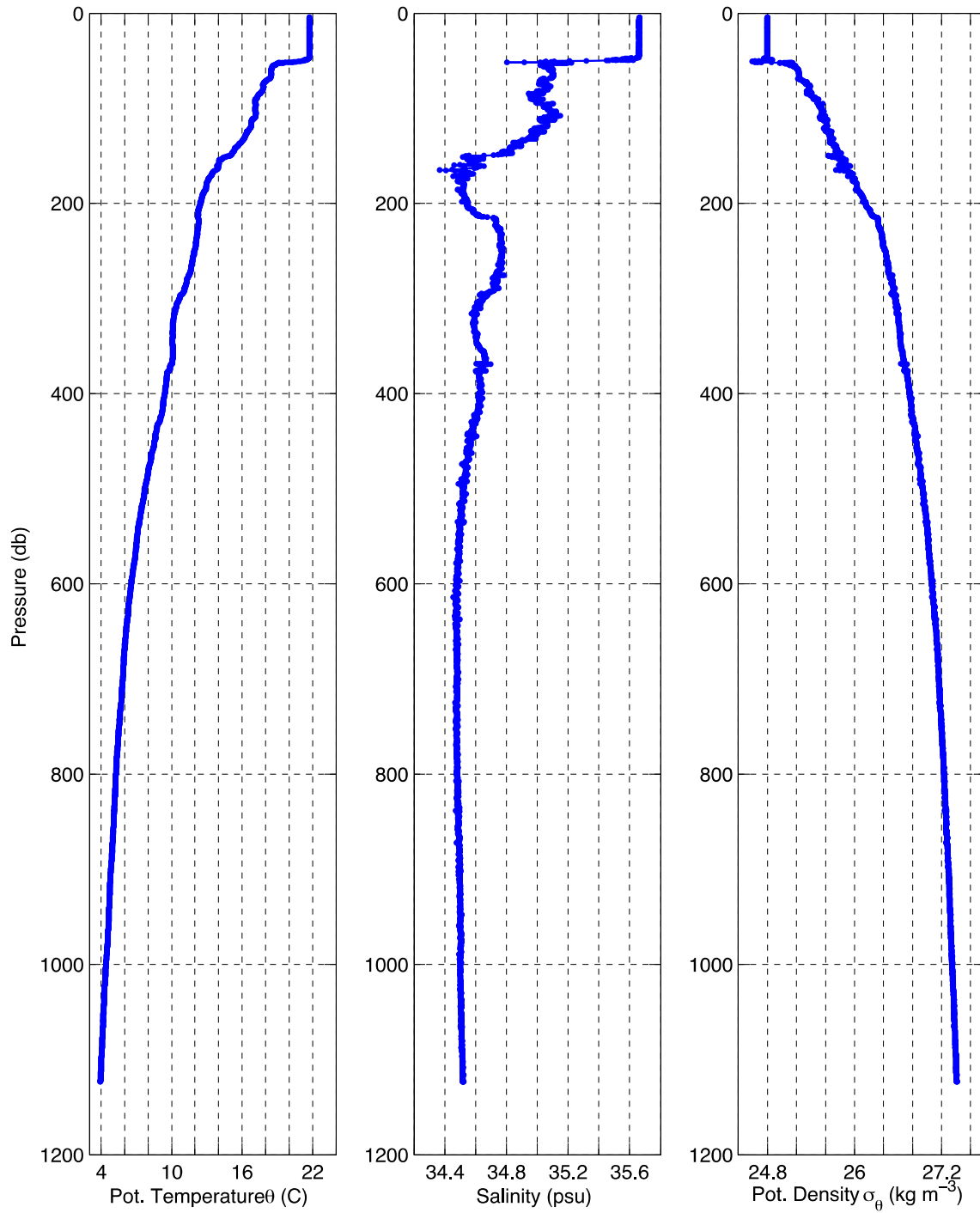

Figure 5-1. CTD profile data collected on April 22 2015 while on station near newly deployed Stratus 14 buoy. CTD sensor is SBE 19 from *Cabo de Hornos*.



Figure 5-2. Same as Fig. 5-1 but with data truncated to upper 250 m.

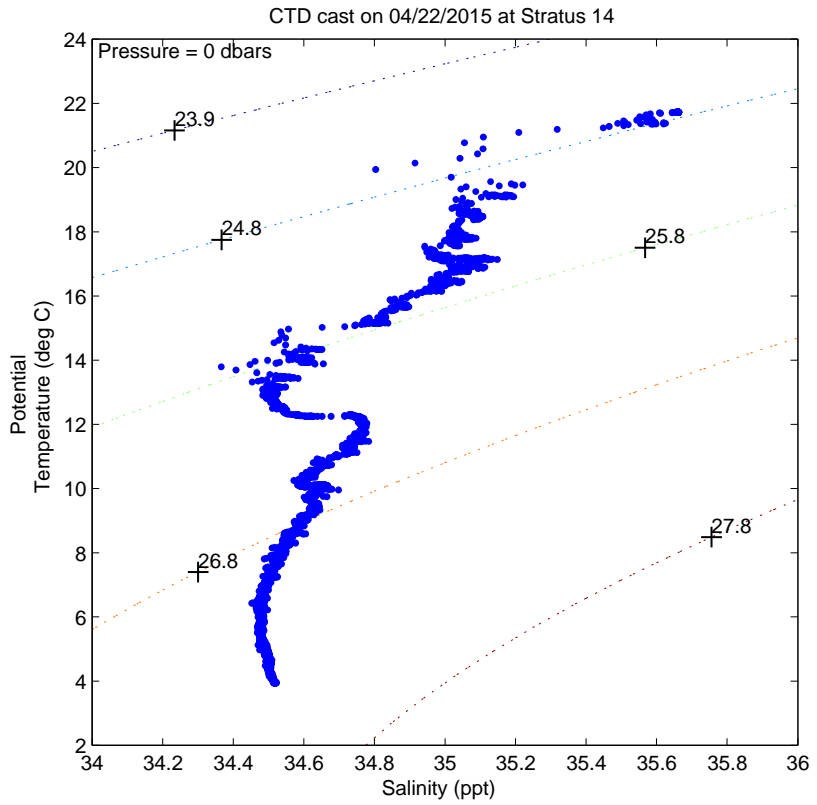

Figure 5-3. T-S plot using same data as in Fig. 5-1.

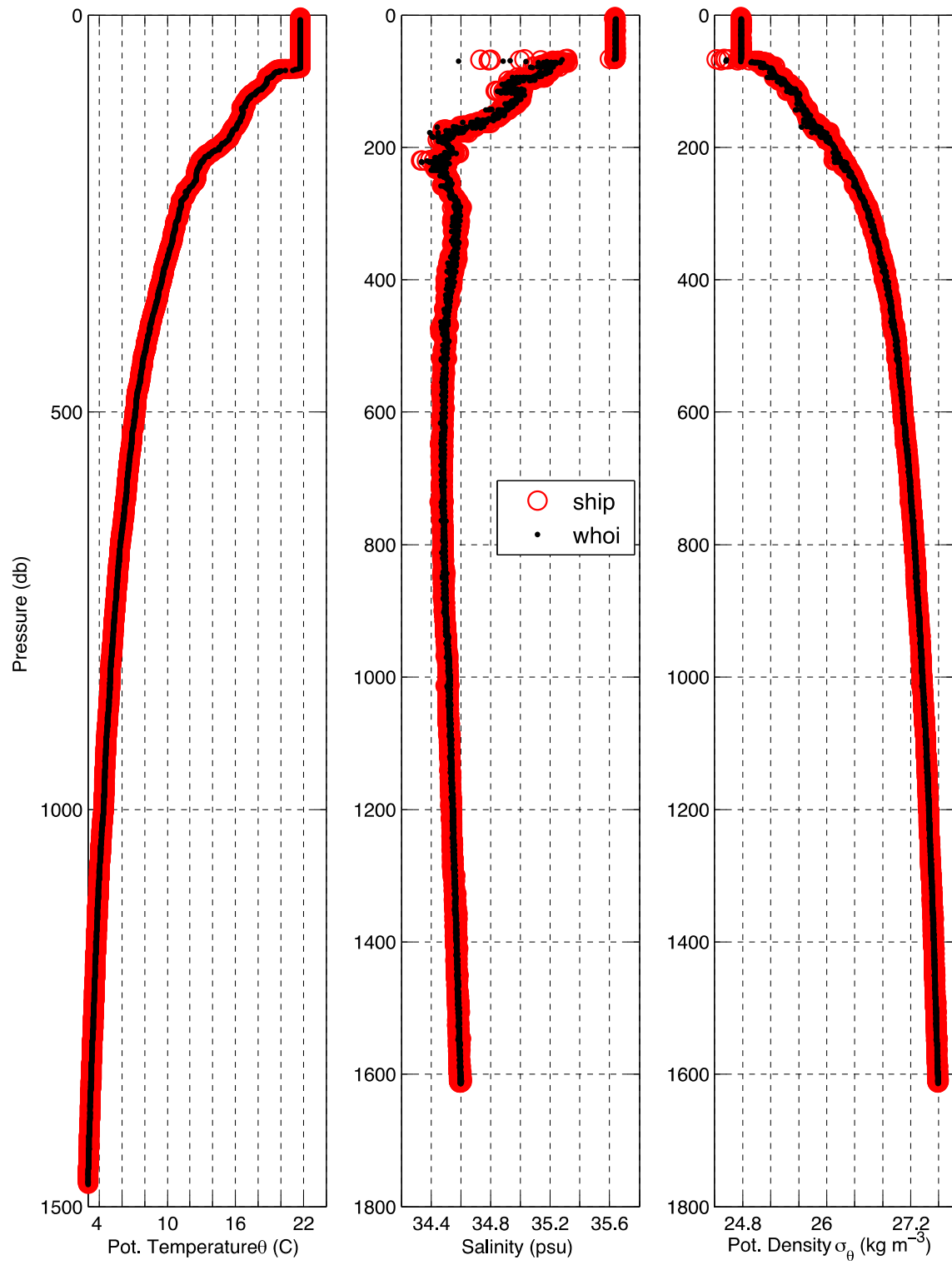

Figure 5-4. CTD profile data collected on April 23 2015 while on station near Stratus 13 buoy using ship’s sensor (red open circle) and UOP sensor (black dots).

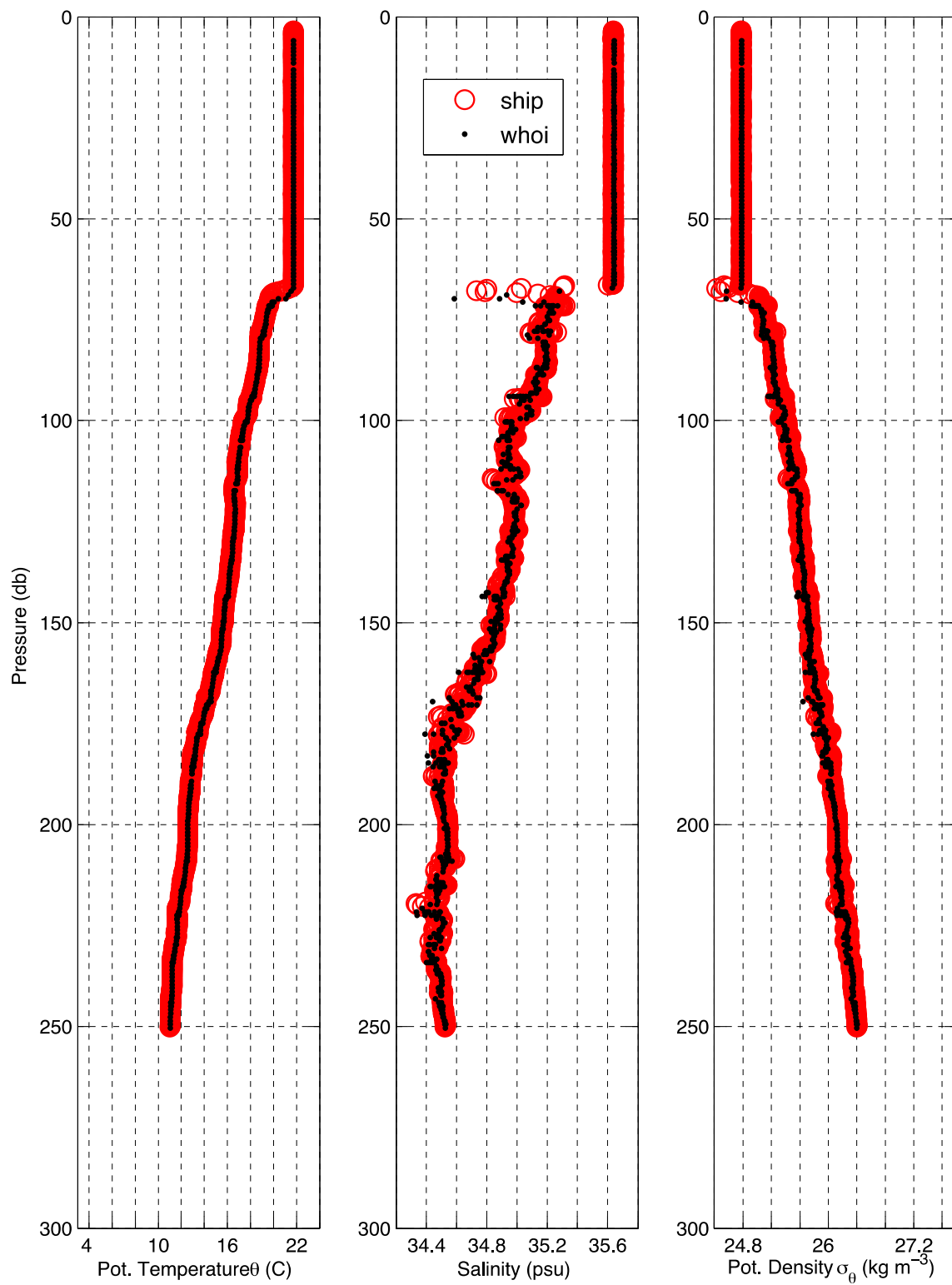

Figure 5-5. Same as Figure 5-4 but using data truncated to upper 250 m.

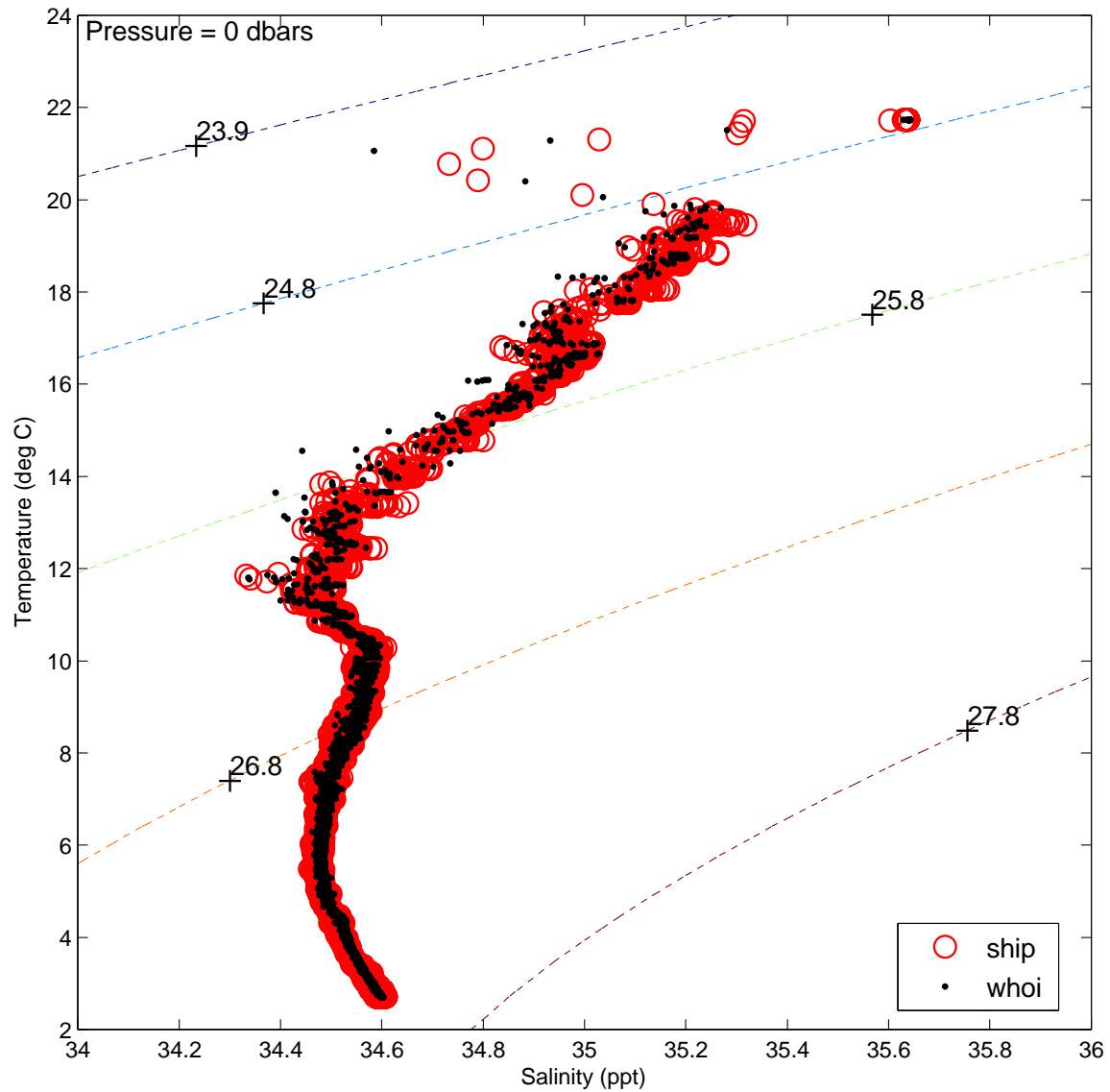

Figure 5-6. T-S plot using same data as in Fig 5-4. Potential temperature versus salinity.

B. Drifters

Surface drifters (20) were launched during the Stratus 14 cruise onboard *Cabo de Hornos*. Locations and times are described in Table 5-1.

Table 5-1. Drifter launches during Stratus 14 cruise onboard *Cabo de Hornos*, April 2015.

Drifter	ID	Time (UTC)	Date	Lat	Long
1	300234062554980	15:00	19 April 2015	23° 14.840'S	82° 07.046'W
2	300234062552990	15:00	19 April 2015	23° 14.840'S	82° 07.046'W
3	300234062651120	18:00	19 April 2015	22° 45.500'S	82° 29.450'W
4	300234062652100	18:00	19 April 2015	22° 45.500'S	82° 29.450'W
5	300234062652110	21:00	19 April 2015	22° 16.000'S	82° 51.500'W
6	300234062654110	21:00	19 April 2015	22° 16.000'S	82° 51.500'W
7	00234062654100	21:00	19 April 2015	22° 16.000'S	82° 51.500'W
8	300234062658110	00:12	20 April 2015	21° 45.736'S	83° 14.857'W
9	300234062659100	00:12	20 April 2015	21° 45.736'S	83° 14.857'W
10	300234062655100	00:12	20 April 2015	21° 45.736'S	83° 14.857'W
11	300234062338980	05:00	20 April 2015	21° 00.000'S	83° 49.700'W
12	300234062659110	05:00	20 April 2015	21° 00.000'S	83° 49.700'W
13	300234062655110	05:00	20 April 2015	21° 00.000'S	83° 49.700'W
14	300234062650110	20:00	24 April 2015	19° 38.808'S	84° 55.456'W
15	300234062551990	20:00	24 April 2015	19° 38.808'S	84° 55.456'W
16	300234062550980	20:00	24 April 2015	19° 38.808'S	84° 55.456'W
17	300234062559980	22:00	24 April 2015	19° 43.658'S	84° 39.443'W
18	300234062651110	22:00	24 April 2015	19° 43.658'S	84° 39.443'W
19	300234062650120	23:45	24 April 2015	19° 49.404'S	84° 20.486'W
20	300234062651000	23:45	24 April 2015	19° 49.404'S	84° 20.486'W

Thanks and Acknowledgements

We wish to thank all the crew of the *Cabo de Hornos* who welcomed us on board. Special thanks go to the officers who made this a safe and successful sailing journey, and to the deck crew who gave us a strong hand with our mooring operations.

References

- Colbo K. and Weller R. A., 2009. Accuracy of the IMET Sensor Package in the Subtropics. *Journal of Atmospheric and Oceanic Technology*, vol. **26**, pp 1867-1890.
- Serra Y. L. and A'Hearn P., Freitag H. P., McPhaden M. J., 2001. ATLAS self-siphoning rain gauge error estimates. *Journal of Atmospheric and Oceanic Technology*, vol.**18**, pp 1989-2002.

APPENDIX 1. Stratus 14 buoy spin in Woods Hole on January 23 2015.

For this procedure, the vanes of the wind anemometers are blocked towards a known heading, while the buoy itself is oriented in 8 different directions.

Heading = 0, Turn = 0

Vanes Secured at 13:45 UTC

System 1		Vane	Compass	Direction	Sample Time
Logger	L01				
WND	344	355.7	359.2	355	1430
System 2		Vane	Compass	Direction	Sample Time
Logger	L02				
WND	205	354.6	0.3	359.9	1437
Standalone		Vane	Compass	Direction	Sample Time
WXT520	008	N/A	0.7	N/A	1415

Heading = 0, Turn = 45

Vanes Secured at 14:44 UTC

System 1		Vane	Compass	Direction	Sample Time
Logger	L01				
WND	344	311.4	45.6	357	1512
System 2		Vane	Compass	Direction	Sample Time
Logger	L02				
WND	205	314.2	46.7	0.9	1513
Standalone		Vane	Compass	Direction	Sample Time
WXT520	008	N/A	0.7	N/A	0915

Heading = 0, Turn = 90

Vanes Secured at 15:24 UTC

System 1		Vane	Compass	Direction	Sample Time
Logger	L01				
WND	344	267.6	91.8	359.4	1545
System 2		Vane	Compass	Direction	Sample Time
Logger	L02				
WND	205	268.3	90.3	358.6	1545
Standalone		Vane	Compass	Direction	Sample Time
WXT520	008	N/A	87.8	N/A	1555

Heading = 0, Turn = 135

Vanes Secured at 16:00 UTC

System 1		Vane	Compass	Direction	Sample Time
Logger	L01				
WND	344	222.9	137.4	0.3	1615
System 2		Vane	Compass	Direction	Sample Time
Logger	L02				
WND	205	220.3	134.2	354.5	1620
Standalone		Vane	Compass	Direction	Sample Time
WXT520	008	N/A	132	N/A	1613

Heading = 0, Turn = 180

Vanes Secured at 16:36 UTC

System 1		Vane	Compass	Direction	Sample Time
Logger	L01				
WND	344	178.1	180.6	358.7	1645
System 2		Vane	Compass	Direction	Sample Time
Logger	L02				
WND	205	176.9	178.0	354.9	1647
Standalone		Vane	Compass	Direction	Sample Time
WXT520	008	N/A	177.9	N/A	1643

Heading = 0, Turn = 225

Vanes Secured at 16:55 UTC

System 1		Vane	Compass	Direction	Sample Time
Logger	L01				
SWND	344	133.1	223.5	356.6	1840
System 2		Vane	Compass	Direction	Sample Time
Logger	L02				
WND	205	133.4	223.3	356.7	1841
Standalone		Vane	Compass	Direction	Sample Time
WXT520	008	N/A	225	N/A	1844

Heading = 0, Turn = 270

Vanes Secured at 18:50 UTC

System 1		Vane	Compass	Direction	Sample Time
Logger	L01				
SWND	344	87.6	268.3	355.9	1901
System 2		Vane	Compass	Direction	Sample Time
Logger	L02				
WND	205	90.0	269.0	359.0	1903
Standalone		Vane	Compass	Direction	Sample Time
WXT520	008	N/A	271.5	N/A	1900

Heading = 0, Turn = 315

Vanes Secured at 19:06 UTC

System 1		Vane	Compass	Direction	Sample Time
Logger	L01				
SWND	344	43.1	312.4	355.5	1925
System 2		Vane	Compass	Direction	Sample Time
Logger	L02				
WND	205	46.7	313.5	0.2	1927
Standalone		Vane	Compass	Direction	Sample Time
WXT520	008	N/A	316	N/A	1923

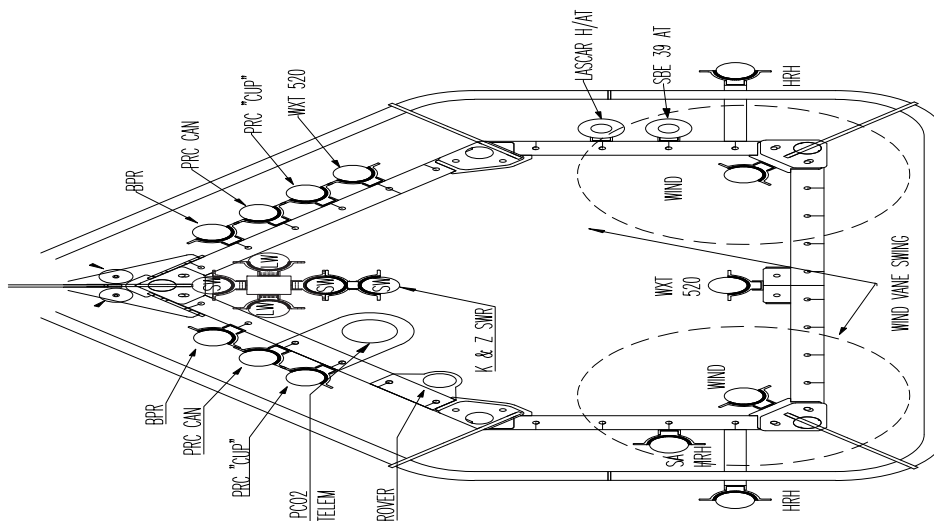

APPENDIX 2. S14 Instrument Setup.

ASIMET Loggers

Logger 1:

LOG01
Model: LOGR53
SerNum: **L-01**
CfgDat: 12APR05
Firmware: LOGR53 v4.11cf
RTClock: 2015/04/11 14:05:09
Logging Interval: 60; Current Tick: 43
R-interval: 1
Compact Flash Card present - Compact Flash
OK!
Volume in drive is L01
Directory of CF:
2015/04/11 13:59 0 L01.INF
2015/04/11 13:59 0 L01.DAT
2 File(s) 0 bytes
256703488 bytes free
Main Battery Voltage: 12.50
BPR failed
HRH failed
LWR failed
PRC failed
SWR failed
WND failed
Last PTT module update OK
32B1C3FFFB51EA7EFF842612C7D1F432ADC
2893B51F17FC001160AC7D1F421C7
32A9BE893B51F17F80000612C7D1F432A5B
A893B51F97C00000612C7D1F4482F
32A1BA893B51F8800000566C7D1F4329DB6
893B51FD7F80000516C7D1F4DB42
Sampling STOPPED
Sampling GO - synchronizing...

LOG01
Model: LOGR53
SerNum: **L-01**
CfgDat: 12APR05
Firmware: LOGR53 v4.11cf
RTClock: 2015/04/11 14:06:22
Logging Interval: 60; Current Tick: 52
R-interval: 1
Compact Flash Card present - Compact Flash
OK!
Main Battery Voltage: 12.50
Last PTT module update OK
32B1C3FFFB51EA7EFF842612C7D1F432ADC
2893B51F17FC001160AC7D1F421C7
32A9BE893B51F17F80000612C7D1F432A5B
A893B51F97C00000612C7D1F4482F
32A1BA893B51F8800000566C7D1F4329DB6
893B51FD7F80000516C7D1F4DB42

Sampling GO

Logger 1:

STR01
Model: STRATUS_2
SerNum: **STR2-02**
CfgDat: 12APR01
Firmware: LOGR53 v4.11cf
RTClock: 2015/04/11 14:55:24
Logging Interval: 60; Current Tick: 29
R-interval: 1
Compact Flash Card present - Compact Flash
OK!
Volume in drive is L02
Directory of CF:
2015/04/11 14:55 0 L02.INF
2015/04/11 14:55 0 L02.DAT
2 File(s) 0 bytes
256703488 bytes free
Main Battery Voltage: 12.50
Last PTT module update OK
32B5C5FE7B51F37CE8816612C7D1F432B1C3
FFFB51F37F3F83A616C7D1F431D7
32ADC2893B51F47F4001060AC7D1F432A9B
E893B51F67DC0003616C7D1F49F91
32A5BE893B51F87C0000361AC7D1F432A1B
A893B51FD8000002562C7D1F47219
Sampling STOPPED
Sampling GO - synchronizing...

STR01
Model: STRATUS_2
SerNum: **STR2-02**
CfgDat: 12APR01
Firmware: LOGR53 v4.11cf
RTClock: 2015/04/11 14:57:02
Logging Interval: 60; Current Tick: 32
R-interval: 1
Compact Flash Card present - Compact Flash
OK!
Volume in drive is L02
Directory of CF:
2015/04/11 14:55 0 L02.INF
2015/04/11 14:55 0 L02.DAT
2 File(s) 0 bytes
256703488 bytes free
Main Battery Voltage: 12.50
Last PTT module update OK
32B5C5FE7B51F37CE8816612C7D1F432B1C3
FFFB51F37F3F83A616C7D1F431D7
32ADC2893B51F47F4001060AC7D1F432A9B
E893B51F67DC0003616C7D1F49F91

32A5BE893B51F87C0000361AC7D1F432A1B
A893B51FD8000002562C7D1F47219

Sampling GO

ASIMET Standalones

SWR Kipp and Zonen:

2015/04/11 17:39:30

SWR01

801

VOSSWR53 v4.01cf

2.4576 Mhz

23SEP14

2015/04/11 17:39:39

Use 'Q'query command to get constants from
VOSHPS front end

Compact Flash Card present - Compact Flash
OK!

Volume in drive is SWR801

Directory of CF:

2014/10/31 20:09 0 SWR801.INF

2015/04/11 16:59 93696

SWR801.DAT

2 File(s) 93696 bytes

256609792 bytes free

Enter Compact Flash Cmnd, ? or H for Help: I
Initialize CF! ALL current Data will be
ERASED! Are you Sure? (Y\N) [Enter=N] Y
Capacity(bytes) = 256703488

Sectors/Cluster = 16

Sectors/Track = 32

Number-of-Heads = 16

Clusters = 31340

Boot written

Starting FAT Write

FAT written @ Sector 123

Type in 0 to 11 char Volume name + Enter

SWR801

Type in 1 to 8 char INFO file name + Enter (No
Extension) SWR801

Type in 1 to 8 char DATA file name + Enter (No
Extension) SWR801

Data starts @ cluster 6

Info starts @ cluster 2

Data file max size = 256703488

Sector 257 Written

Root Dir written

CF Initialization Complete

Enter Compact Flash Cmnd, ? or H for Help: Q

Quitting Compact Flash Ops

SWR01

801

VOSSWR53 v4.01cf

2.4576 Mhz

23SEP14

2015/04/11 17:40:58

Use 'Q'query command to get constants from
VOSHPS front end

Compact Flash Card present - Compact Flash
OK!

Volume in drive is SWR801

Directory of CF:

2015/04/11 17:40 0 SWR801.INF

2015/04/11 17:40 0 SWR801.DAT

2 File(s) 0 bytes

256703488 bytes free

HRH Sensirion:

HRH01

233

VOSHRH53 v4.43cf

20JAN15

2015/04/20 16:01:45

Use 'Q'query command to get constants from
VOSHPS front end

Compact Flash Card present - Compact Flash
OK!

Volume in drive is HRH233

Directory of CF:

2015/04/11 13:17 0 HRH233.INF

2015/04/20 15:59 53248

HRH233.DAT

2 File(s) 53248 bytes

256650240 bytes free

Vaisala WXT520:

VWX01

VWX008

VOSWXT520 v4.04cf

24JUL14

2015/04/14 14:40:22

Compact Flash Card present - Compact Flash
OK!

Volume in drive is VWX008

Directory of CF:

2015/04/14 14:39 0 VWX008.INF

2015/04/14 14:39 0 VWX008.DAT

2 File(s) 0 bytes

512261120 bytes free

SBE39AT:

start time = 17 Apr 2015 22:00:00

SBE 39

S>ds

SBE 39 V 3.1b SERIAL NO. 5275 17 Apr
 2015 21:45:02
 battery voltage = 7.9
 not logging: waiting to start at 17 Apr 2015
 22:00:00
 sample interval = 300 seconds
 samplenum = 1834, free = 4698033
 serial sync mode disabled
 real-time output disabled
 SBE 39 configuration = temperature only
 binary upload does not include time
 temperature = 21.44 deg C
 S>ds

SBE 39 V 3.1b SERIAL NO. 5275 17 Apr
 2015 21:45:11
 battery voltage = 7.9
 not logging: waiting to start at 17 Apr 2015
 22:00:00
 sample interval = 300 seconds
 samplenum = 1834, free = 4698033
 serial sync mode disabled
 real-time output disabled
 SBE 39 configuration = temperature only
 binary upload does not include time
 temperature = 21.44 deg C
 S>

Lascar (see picture below):

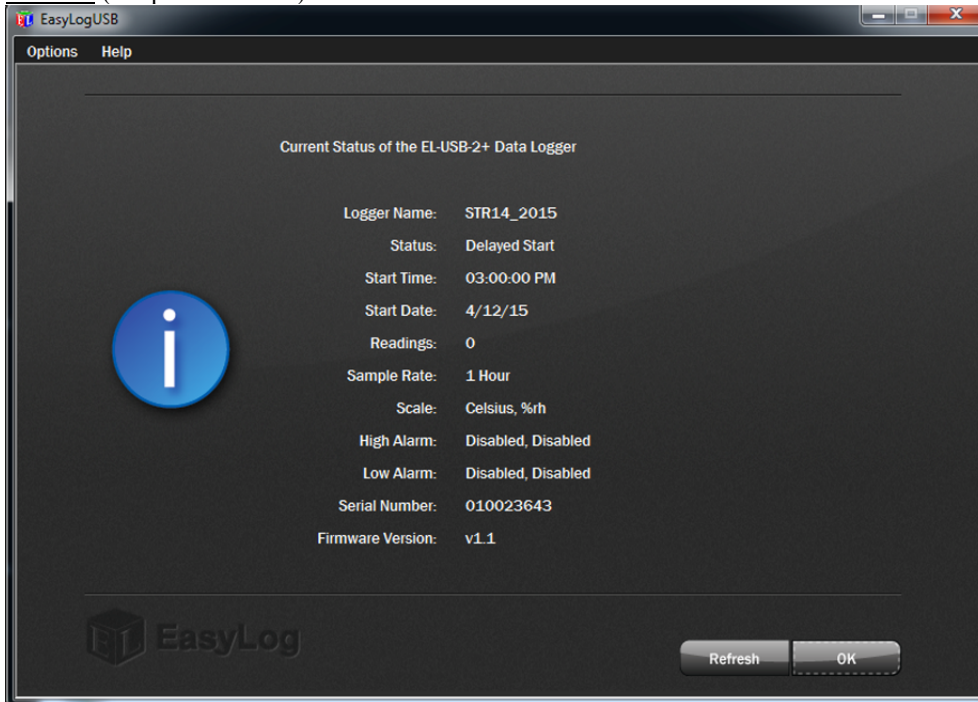

SUBSURFACE

Seaguard#235:

20150113 EGH - Seaguard DCS 4520 Service
 Log
 Seaguard RCM DW, product #4451, SN#235
 DCS product #4520 SN#455
 Oxygen Optode Sensor product# 4330 SN#682
 2 Lithium batteries, degaussed, installed - 7 vdc
 O-ring replaced and lightly greased
 compass verified (analogue analysis on compass
 dial) - 0.2 degree @ 360 (excell file:
 S14_Seaguard_compass-
 evaluation_20150114EGH)

Deployment Set-up:

Control Panel

set time

zero card

SYSTEM CONFIG

DCS:

pings =300

sound speed= 1500

start distance= .5m

cell size= 2.5m

burst mode= y

fixed= no

tilt compensation= on

z pulse active= on
x axis normal
y axis normal
forward ping active = y

OPTODE:

enable airsat = y
enable raw data= y
enable temp= y
enable hum comp= y

Deployment Settings

**Platform, Recorder, Storage Manager
(wizard)**

Site Info
Sample Interval= 30 minutes
Start when powered on
Enabled Sensors
Store Internally= y

Admin Tools

Calculator

30 minute sample 1800 seconds
2 lithium 7v, 30 Ah
battery days= 706
memory days= 175,000 (see notes)

Export config file to card

SET START: 20150401 01:00:00

Seaguard#238:

20150113 EGH - Seaguard DCS 4520 Service
Log
Seaguard RCM DW, product #4451, SN#238
DCS product #4520 SN#451
Oxygen Optode Sensor product# 4330 SN#683
2 Lithium batteries, degaussed, installed - 7 vdc
O-ring replaced and lightly greased
compass verified (analogue analysis on compass
dial) - 0.3 degree @ 360 (excell file):
S14_Seaguard_compass-
evaluation_20150114EGH)

SeaguardII#1500:

*Setup for this instrument was changed several times. Last setup known (April 18 2015, 21:31 UTC) had sound speed value changed to 1509 m s⁻¹. The following copy of the setup file does not reflect this.

Set Enable upside down(yes)
Set Bandwidth(Narrowband)
Set Ping Number(300)
Set Enable Burst Mode(Yes)
Set Enable Surface Cell(No)
Set C1 Enable Surface Reference(No)
Set C1 Cell Size(5.0m)
Set C1 Distance First Cell(3.5m)
Set C1 Number Of Cells(20)
Set C1 Cell Overlap(0)
Set C2 Enable Column(Yes)
Set C2 Enable Surface Reference(No)

Deployment Set-up:

Control Panel

set time
zero card

SYSTEM CONFIG

DCS:

pings =300
sound speed= 1500
start distance= .5m
cell size= 2.5m
burst mode= y
fixed= no
tilt compensation= on
z pulse active= on
x axis normal
y axis normal
forward ping active = y

OPTODE:

enable airsat = y
enable raw data= y
enable temp= y
enable hum comp= y

Deployment Settings

**Platform, Recorder, Storage Manager
(wizard)**

Site Info
Sample Interval= 30 minutes
Start when powered on
Enabled Sensors
Store Internally= y

Admin Tools

Calculator

30 minute sample 1800 seconds
2 lithium 7v, 30 Ah
battery days= 706
memory days= 175,000 (see notes)

Export config file to card

SET START: 20150401 01:00:00

Set C2 Cell Size(2.0m)
Set C2 Distance First Cell(2.0m)
Set C2 Number Of Cells(50)
Set C2 Cell Overlap(0)
Set C3 Enable Column(No)
Set Enable NE Speed(Yes)
Set Enable 3-Beam Combinations(Yes)
Set Enable AutoBeam(Yes)
Set Enable Vertical Speed(Yes)
Set Enable Strength(Yes)
Set Enable Beam Speed(Yes)
Set Enable Beam Strength(Yes)

Set Enable Heading(Yes)	Set Enable Salinity(Yes)
Set Enable Pitch Roll(Yes)	Set Enable Density(Yes)
Set Enable Abs Tilt(Yes)	Set Pressure Sensor Id(4117B-1051)
Set Enable Max Tilt(Yes)	Set Pressure Parameter Id(1)
Set Enable Tilt Direction(Yes)	Set Temperature Sensor Id(4060-672)
Set Enable Std Dev Speed(Yes)	Set Temperature Parameter Id(2)
Set Enable Std Dev Beam Speed(Yes)	Set Conductivity Sensor Id(4319-734)
Set Enable Cross Difference(Yes)	Set Conductivity Parameter Id(1)
Set Enable Correlation Factor(No)	Set enable fft peak filter(no)
Set Enable Std Dev Heading(Yes)	Set Enable Sensor Derived Sound Speed(No)
Set Enable Std Dev Tilt(Yes)	Set Sound Speed(1500.0) [*see note above]
Set Enable Speed Of Sound(Yes)	
Set Enable Depth(Yes)	

RDI Workhorse#12254:

```

Instrument S/N: 12254
  Frequency: 307200 HZ
  Configuration: 4 BEAM, JANUS
  Match Layer: 10
  Beam Angle: 20 DEGREES
  Beam Pattern: CONVEX
  Orientation: UP
  Sensor(s): HEADING TILT 1 TILT 2 TEMPERATURE
Temp Sens Offset: -0.15 degrees C
  CPU Firmware: 50.36 [0]
  Boot Code Ver: Required: 1.13 Actual: 1.13
  DEMOD #1 Ver: ad48, Type: 1f
  DEMOD #2 Ver: ad48, Type: 1f
  PWRTIMG Ver: 85d3, Type: 4
Board Serial Number Data:
  50 00 00 05 88 CB C8 09 PIO727-3000-00G
  6D 00 00 05 89 4C AD 09 DSP727-2001-04G
  50 00 00 05 88 C6 7D 09 REC727-1000-04E
  E7 00 00 05 88 C9 5F 09 CPU727-2000-00J
>deploy?
Deployment Commands:
CF = 11101 ----- Flow Ctrl (EnsCyc;PngCyc;Binry;Ser;Rec)
CK ----- Keep Parameters as USER Defaults
CR # ----- Retrieve Parameters (0 = USER, 1 = FACTORY)
CS ----- Start Deployment
EA = +00000 ----- Heading Alignment (1/100 deg)
EB = +00000 ----- Heading Bias (1/100 deg)
ED = 01350 ----- Transducer Depth (0 - 65535 dm)
ES = 35 ----- Salinity (0-40 pp thousand)
EX = 11111 ----- Coord Transform (Xform: Type,Tilts,3 Bm,Map)
EZ = 1111101 ----- Sensor Source (C,D,H,P,R,S,T)
RE ----- Recorder ErAsE
RN ----- Set Deployment Name
TE = 01:00:00.00 ----- Time per Ensemble (hrs:min:sec.sec/100)
TF = 15/04/18,01:00:00 --- Time of First Ping (yr/mon/day,hour:min:sec)
TP = 00:01.00 ----- Time per Ping (min:sec.sec/100)
TS = 15/04/18,00:31:28 --- Time Set (yr/mon/day,hour:min:sec)
WD = 111 100 000 ----- Data Out (Vel,Cor,Amp; PG,St,P0; P1,P2,P3)
WF = 0176 ----- Blank After Transmit (cm)
Press any key to continue

```

WN = 012 ----- Number of depth cells (1-128)
WP = 00150 ----- Pings per Ensemble (0-16384)
WS = 0800 ----- Depth Cell Size (cm)
WV = 175 ----- Mode 1 Ambiguity Vel (cm/s radial)

>ck

[Parameters saved as USER defaults]

>cs

VMCMs:

VM001
Model: STAR ENGINEERIN
SerNum: **VM2010**
CfgDat: 10APR02
Firmware: VMCM2 v3.24
RTClock: 2015/04/14 17:20:03
Logging Interval: 60; Current Tick: 18
Compass Ontime=2 Offtime=13
EDI Intel-compatible 20MB PCMCIA CARD
present - CARD OK!
FLASH card capacity: 20840436
Records used: 1; available: 612953
Main Battery Voltage: 0.00
TPOD Firmware: VMTPOD53 v3.00
TPOD Info: VMTPOD VMT010 07AUG14
THERM010
Sampling GO

VM001
Model: STAR ENGINEERIN
SerNum: **VM0061**
CfgDat: 09APR02
Firmware: VMCM2 v3.24
RTClock: 2015/04/14 17:17:19
Logging Interval: 60; Current Tick: 4
Compass Ontime=2 Offtime=13
EDI Intel-compatible 20MB PCMCIA CARD
present - CARD OK!
FLASH card capacity: 20840436
Records used: 0; available: 612954
Main Battery Voltage: 0.00
TPOD Firmware: VMTPOD53 v3.00
TPOD Info: VMTPOD VMT061 06AUG14
THERM061
Sampling GO
Aborting delayed start - entering STOP mode

VM001
Model: STAR ENGINEERIN
SerNum: **VM2059**
CfgDat: 15APR02
Firmware: VMCM2 v3.24
RTClock: 2015/04/14 17:04:58
Logging Interval: 60; Current Tick: 28
Compass Ontime=2 Offtime=13

EDI Intel-compatible 20MB PCMCIA CARD
present - CARD OK!
FLASH card capacity: 20840436
Records used: 0; available: 612954
Main Battery Voltage: 0.00
TPOD Firmware: VMTPOD53 v3.00
TPOD Info: VMTPOD VMT059
Sampling GO
Aborting delayed start - entering STOP mode

VM001
Model: STAR ENGINEERIN
SerNum: **VM2068**
CfgDat: 16APR02
Firmware: VMCM2 v3.24
RTClock: 2015/04/14 16:56:58
Logging Interval: 60; Current Tick: 14
Compass Ontime=2 Offtime=13
EDI Intel-compatible 40MB PCMCIA CARD
present - CARD OK!
FLASH card capacity: 41811942
Records used: 0; available: 1229763
Main Battery Voltage: 0.00
TPOD Firmware: VMTPOD53 v3.00
TPOD Info: VMT068 10SEP14 THERM068
Sampling GO
Aborting delayed start - entering STOP mode

VM001
Model: STAR ENGINEERIN
SerNum: **VM2058**
CfgDat: 16APR02
Firmware: VMCM2 v3.24
RTClock: 2015/04/14 16:55:38
Logging Interval: 60; Current Tick: 23
Compass Ontime=2 Offtime=13
EDI Intel-compatible 20MB PCMCIA CARD
present - CARD OK!
FLASH card capacity: 20840436
Records used: 3; available: 612951
Main Battery Voltage: 0.00
TPOD Firmware: VMTPOD53 v3.00
TPOD Info: VMTPOD VMT058 07AUG14
THERM058

Sampling GO

VM001
Model: STAR ENGINEERIN
SerNum: **VM0035**
CfgDat: 08APR02
Firmware: VMCM2 v3.24
RTClock: 2015/04/15 16:44:37
Logging Interval: 60; Current Tick: 36
Compass Ontime=2 Offtime=13

SBE37s (SST):

S>#01DS
SBE37-SM 485 V 2.3b SERIAL NO. **1725** 11
Apr 2015 18:42:34
not logging: waiting to start at 11 Apr 2015
20:00:00
sample interval = 300 seconds
samplenum = 0, free = 21520839
store time with each sample
do not output salinity with each sample
do not output sound velocity with each sample
reference pressure = 0.0 db
do not output density with each sample
do not output depth with each sample
A/D cycles to average = 4
internal pump not installed
temperature = 23.18 deg C

SBE37s:

SBE37-SM V 2.6b SERIAL NO. **1304** 15 Jan
2015 20:06:44
not logging: waiting to start at 01 Apr 2015
01:00:00
sample interval = 300 seconds
samplenum = 0, free = 233016
do not transmit real-time data
do not output salinity with each sample
do not output sound velocity with each sample
store time with each sample
number of samples to average = 4
reference pressure = 0.0 db
serial sync mode disabled
wait time after serial sync sampling = 30 seconds
internal pump not installed
temperature = 21.51 deg C

SBE37-SM V 2.6b SERIAL NO. **3821** 16 Jan
2015 18:10:48
not logging: waiting to start at 01 Apr 2015
01:00:00
sample interval = 300 seconds
samplenum = 0, free = 233016
do not transmit real-time data

EDI Intel-compatible 20MB PCMCIA CARD
present - CARD OK!
FLASH card capacity: 20840436
Records used: 0; available: 612954
Main Battery Voltage: 0.00
TPOD Firmware: VMTPOD53 v3.00
TPOD Info: VMTPOD VMT035 07AUG14
THERM035
Sampling GO
Aborting delayed start - entering STOP mode

#01DS
SBE37-SM 485 V 2.3b SERIAL NO. **1839** 11
Apr 2015 19:15:04
not logging: waiting to start at 11 Apr 2015
20:00:00
sample interval = 300 seconds
samplenum = 0, free = 21520839
store time with each sample
do not output salinity with each sample
do not output sound velocity with each sample
reference pressure = 0.0 db
do not output density with each sample
do not output depth with each sample
A/D cycles to average = 4
internal pump not installed
temperature = 23.29 deg C

do not output salinity with each sample
do not output sound velocity with each sample
store time with each sample
number of samples to average = 4
reference pressure = 0.0 db
serial sync mode disabled
wait time after serial sync sampling = 30 seconds
internal pump not installed
temperature = 22.11 deg C

SBE37-SM V 2.6b SERIAL NO. **3824** 16 Jan
2015 18:26:30
not logging: waiting to start at 01 Apr 2015
01:00:00
sample interval = 300 seconds
samplenum = 0, free = 233016
do not transmit real-time data
do not output salinity with each sample
do not output sound velocity with each sample
store time with each sample
number of samples to average = 4
reference pressure = 0.0 db
serial sync mode disabled
wait time after serial sync sampling = 30 seconds

internal pump not installed
temperature = 21.67 deg C

SBE37-SM V 2.6b SERIAL NO. **1899** 16 Jan
2015 16:34:53

not logging: waiting to start at 01 Apr 2015
01:00:00

sample interval = 300 seconds
samplenum = 0, free = 233016
do not transmit real-time data
do not output salinity with each sample
do not output sound velocity with each sample
store time with each sample
number of samples to average = 4
reference pressure = 0.0 db
serial sync mode disabled
wait time after serial sync sampling = 30 seconds
internal pump not installed
temperature = 22.00 deg C

S>ds

SBE37-SM V 2.6b SERIAL NO. **1900** 15 Jan
2015 21:04:09

logging not started
sample interval = 300 seconds
samplenum = 0, free = 233016
do not transmit real-time data
do not output salinity with each sample
do not output sound velocity with each sample
store time with each sample
number of samples to average = 4
reference pressure = 0.0 db
serial sync mode disabled
wait time after serial sync sampling = 30 seconds
internal pump not installed
temperature = 21.21 deg C

S>startmddy=040115

S>starttimethmmss=010000

start time = 01 Apr 2015 01:00:00

S>startlater

start time = 01 Apr 2015 01:00:00

9393SBE 37-SM

S>ds

SBE37-SM V 2.6b SERIAL NO. **1900** 15 Jan
2015 21:05:45

not logging: waiting to start at 01 Apr 2015
01:00:00

sample interval = 300 seconds
samplenum = 0, free = 233016
do n

SBE37-SM V 2.6b SERIAL NO. **1901** 15 Jan
2015 20:45:26

not logging: waiting to start at 01 Apr 2015
01:00:00

sample interval = 300 seconds

samplenum = 0, free = 233016
do not transmit real-time data
do not output salinity with each sample
do not output sound velocity with each sample
store time with each sample
number of samples to average = 4
reference pressure = 0.0 db
serial sync mode disabled
wait time after serial sync sampling = 30 seconds
internal pump not installed
temperature = 21.87 deg C

SBE37-SM V 2.6b SERIAL NO. **1902** 16 Jan
2015 16:57:45

not logging: waiting to start at 01 Apr 2015
01:00:00

sample interval = 300 seconds
samplenum = 0, free = 233016
do not transmit real-time data
do not output salinity with each sample
do not output sound velocity with each sample
store time with each sample
number of samples to average = 4
reference pressure = 0.0 db
serial sync mode disabled
wait time after serial sync sampling = 30 seconds
internal pump not installed
temperature = 21.05 deg C

SBE37SM-RS232 v3.1 SERIAL NO. **8004** 13
Apr 2015 11:34:19

vMain = 7.02, vLith = 3.12
samplenum = 0, free = 559240
not logging, waiting to start at 13 Apr 2015
12:00:00

sample interval = 300 seconds
data format = converted engineering
transmit real-time = no
sync mode = no
pump installed = no

SBE37-SM V 2.6b SERIAL NO. **1903** 20 Jan
2015 17:05:22

not logging: waiting to start at 01 Apr 2015
01:00:00

sample interval = 300 seconds
samplenum = 0, free = 233016
do not transmit real-time data
do not output salinity with each sample
do not output sound velocity with each sample
store time with each sample
number of samples to average = 4
reference pressure = 0.0 db
serial sync mode disabled
wait time after serial sync sampling = 30 seconds
internal pump not installed

temperature = 20.83 deg C

SBE37-SM V 2.6b SERIAL NO. **1905** 22 Jan 2015 21:54:22

not logging: waiting to start at 01 Apr 2015 01:00:00
sample interval = 300 seconds
samplenum = 0, free = 233016
do not transmit real-time data
do not output salinity with each sample
do not output sound velocity with each sample
store time with each sample
number of samples to average = 4
reference pressure = 0.0 db
serial sync mode disabled
wait time after serial sync sampling = 30 seconds
internal pump not installed
temperature = 22.39 deg C

SBE37-SM V 2.6b SERIAL NO. **1907** 22 Jan 2015 21:35:31

not logging: waiting to start at 01 Apr 2015 01:00:00
sample interval = 300 seconds
samplenum = 0, free = 233016
do not transmit real-time data
do not output salinity with each sample
do not output sound velocity with each sample
store time with each sample
number of samples to average = 4
reference pressure = 0.0 db
serial sync mode disabled
wait time after serial sync sampling = 30 seconds
internal pump not installed
temperature = 22.25 deg C

SBE37SM-RS232 v3.1 SERIAL NO. **2011** 13 Apr 2015 11:40:45

vMain = 6.94, vLith = 3.14
samplenum = 0, free = 838860
not logging, waiting to start at 13 Apr 2015 12:00:00
sample interval = 300 seconds
data format = converted engineering
transmit real-time = no
sync mode = no
pump installed = no
reference pressure = 0.0 decibars

SBE39s:

SBE 39 V 1.7a SERIAL NO. **00039** 27 Jan 2015 20:06:46

not logging: waiting to start at 01 Apr 2015 01:00:00

SBE37-SM V 1.6 SERIAL NO. **0010** 21 Jan 2015 20:55:04

not logging: waiting to start at 01 Apr 2015 01:00:00
sample interval = 300 seconds
samplenum = 0, free = 115598
do not transmit real-time data
store time with each sample
A/D cycles to average = 4
reference pressure = 0.0 db
serial sync mode disabled
wait time after serial sync sampling = 120 seconds
temperature = 23.26 deg C

SBE37SM-RS232 v3.1 SERIAL NO. **7836** 13 Apr 2015 11:45:59

vMain = 6.95, vLith = 3.14
samplenum = 0, free = 559240
not logging, waiting to start at 13 Apr 2015 12:00:00
sample interval = 300 seconds
data format = converted engineering
transmit real-time = no
sync mode = no
pump installed = no

SBE37SM-RS232 v3.1 SERIAL NO. **10600** 13 Apr 2015 11:26:21

vMain = 7.00, vLith = 3.21
samplenum = 0, free = 559240
not logging, waiting to start at 13 Apr 2015 12:00:00
sample interval = 300 seconds
data format = converted engineering alternate
transmit real-time = no
sync mode = no
pump installed = no

SBE37SM-RS232 v3.1 SERIAL NO. **10601** 13 Apr 2015 11:18:01

vMain = 6.92, vLith = 3.20
samplenum = 0, free = 559240
not logging, waiting to start at 13 Apr 2015 12:00:00
sample interval = 300 seconds
data format = converted engineering alternate
transmit real-time = yes
sync mode = no
pump installed = no

sample interval = 300 seconds
samplenum = 0, free = 299593
serial sync mode disabled
real-time output disabled

SBE 39 configuration = temperature only
binary upload does not include time
temperature = 22.85 deg C

SBE 39 V 1.7a SERIAL NO. **00041** 27 Jan
2015 19:19:28
not logging: waiting to start at 01 Apr 2015
01:00:00
sample interval = 300 seconds
samplenum = 0, free = 299593
serial sync mode disabled
real-time output disabled
SBE 39 configuration = temperature only
binary upload does not include time
temperature = 21.08 deg C

SBE 39 V 1.7a SERIAL NO. **00053** 27 Jan
2015 19:56:43
not logging: waiting to start at 01 Apr 2015
01:00:00
sample interval = 300 seconds
samplenum = 0, free = 299593
serial sync mode disabled
real-time output disabled
SBE 39 configuration = temperature only
binary upload does not include time
temperature = 20.41 deg C

SBE 39 V 1.7a SERIAL NO. **00101** 27 Jan
2015 19:44:20
not logging: waiting to start at 01 Apr 2015
01:00:00
sample interval = 300 seconds
samplenum = 0, free = 299593
serial sync mode disabled
real-time output disabled
SBE 39 configuration = temperature only
binary upload does not include time
temperature = 22.66 deg C

SBE 39 V 1.7a SERIAL NO. **00721** 12 Apr
2015 17:56:30
not logging: waiting to start at 12 Apr 2015
18:00:00
sample interval = 300 seconds
samplenum = 0, free = 299593
serial sync mode disabled
real-time output disabled
SBE 39 configuration = temperature only
binary upload does not include time
temperature = 18.46 deg C

SBE 39 V 2.0 SERIAL NO. **1502** 27 Jan
2015 22:34:13

battery voltage = 9.1
not logging: waiting to start at 01 Apr 2015
01:00:00
sample interval = 300 seconds
samplenum = 0, free = 599186
serial sync mode disabled
real-time output disabled
SBE 39 configuration = temperature only
binary upload does not include time
temperature = 22.66 deg C

SBE 39 V 2.2 SERIAL NO. **1509** 27 Jan
2015 23:17:53
battery voltage = 8.9
not logging: waiting to start at 01 Apr 2015
01:00:00
sample interval = 300 seconds
samplenum = 0, free = 599186
serial sync mode disabled
real-time output disabled
SBE 39 configuration = temperature only
binary upload does not include time
temperature = 22.36 deg C

SBE 39 V 2.2 SERIAL NO. **1511** 27 Jan
2015 19:31:21
battery voltage = 9.1
not logging: waiting to start at 01 Apr 2015
01:00:00
sample interval = 300 seconds
samplenum = 0, free = 599186
serial sync mode disabled
real-time output disabled
SBE 39 configuration = temperature only
binary upload does not include time
temperature = 22.18 deg C

SBE 39 V 2.2 SERIAL NO. **1511** 11 Apr
2015 18:00:34
battery voltage = 8.6
logging data
sample interval = 300 seconds
samplenum = 3085, free = 596101
serial sync mode disabled
real-time output disabled
SBE 39 configuration = temperature only
binary upload does not include time
temperature = 20.28 deg C

SBE 39 V 3.0b SERIAL NO. **3423** 27 Jan
2015 21:21:34
battery voltage = 9.0
not logging: waiting to start at 01 Apr 2015
01:00:00
sample interval = 300 seconds
samplenum = 0, free = 599186

serial sync mode disabled
real-time output disabled
SBE 39 configuration = temperature only
binary upload does not include time
temperature = 21.20 deg C

SBE 39 V 3.0b SERIAL NO. **3434** 27 Jan
2015 20:55:46
battery voltage = 9.0
not logging: waiting to start at 01 Apr 2015
01:00:00
sample interval = 300 seconds
samplenum = 0, free = 599186
serial sync mode disabled
real-time output disabled
SBE 39 configuration = temperature only
binary upload does not include time
temperature = 20.45 deg C
SBE 39 V 3.0b SERIAL NO. **3435** 28 Jan
2015 20:02:06
battery voltage = 9.1
not logging: waiting to start at 01 Apr 2015
01:00:00
sample interval = 300 seconds
samplenum = 0, free = 599186
serial sync mode disabled
real-time output disabled
SBE 39 configuration = temperature only
binary upload does not include time
temperature = 21.56 deg C

SBE 39 V 3.0b SERIAL NO. **3437** 27 Jan
2015 20:17:52
battery voltage = 9.1

not logging: waiting to start at 01 Apr 2015
01:00:00
sample interval = 300 seconds
samplenum = 0, free = 599186
serial sync mode disabled
real-time output disabled
SBE 39 configuration = temperature only
binary upload does not include time
temperature = 21.30 deg C

SBE 39 V 3.0b SERIAL NO. **3438** 28 Jan
2015 20:05:46
battery voltage = 9.0
not logging: waiting to start at 01 Apr 2015
01:00:00
sample interval = 300 seconds
samplenum = 0, free = 599186
serial sync mode disabled
real-time output disabled
SBE 39 configuration = temperature only
binary upload does not include time
temperature = 19.93 deg C

SBE 39 V 3.0b SERIAL NO. **3439** 27 Jan
2015 22:21:52
battery voltage = 9.0
not logging: waiting to start at 01 Apr 2015
01:00:00
sample interval = 300 seconds
samplenum = 0, free = 599186
serial sync mode disabled
real-time output disabled
SBE 39 configuration = temperature only
binary upload does not include time
temperature = 20.01 deg C

SBE56s:

SeatermUSB - SBE56 V1.8

Exit Refresh Cancel Upload All Report Diagnostics About Help

Connected Devices	Current Configuration	Configuration Options
SBE56 - 1206	Serial Number: 05601206 Firmware Version: SBE56 V0.96 Sample Period (sec): 60.0 Date/Time: 19-Apr-2015 14:3... Start sampling at: 19-Apr-2015 14:4... Current temperature: 24.0075 Events recorded: 0 Battery Changed: 19-Apr-2015 14:3... Number of Samples in Me... 0 Memory Remaining: 30.86 years 100% Calculated battery life remaining: 4.57 years 100% View calibration coefficients	Sample Period: 60 sec <input checked="" type="checkbox"/> Set time to 19-Apr-2015 14:39:07 <input checked="" type="checkbox"/> Clear Memory <input checked="" type="checkbox"/> Clear Events <input checked="" type="checkbox"/> New Battery Installed <input type="radio"/> Start sampling on USB cable disconnect <input checked="" type="radio"/> Start sampling at 19-Apr-2015 14:40:00 Update Configuration Data Upload and Processing Upload Plot Export

Finished configuring device - Success

SeatermUSB - SBE56 V1.8

Exit Refresh Cancel Upload All Report Diagnostics About Help

Connected Devices	Current Configuration	Configuration Options
SBE56 - 1208	Serial Number: 05601208 Firmware Version: SBE56 V0.96 Sample Period (sec): 60.0 Date/Time: 12-Apr-2015 19:1... Start sampling at: 12-Apr-2015 20:0... Current temperature: 22.3428 Events recorded: 0 Battery Changed: 02-Feb-2015 22:0... Number of Samples in Me... 0 Memory Remaining: 30.86 years 100% Calculated battery life remaining: 4.45 years 97% View calibration coefficients	Sample Period: 60 sec <input checked="" type="checkbox"/> Set time to 12-Apr-2015 19:11:41 <input checked="" type="checkbox"/> Clear Memory <input checked="" type="checkbox"/> Clear Events <input type="checkbox"/> New Battery Installed <input type="radio"/> Start sampling on USB cable disconnect <input checked="" type="radio"/> Start sampling at 12-Apr-2015 20:00:00 Update Configuration Data Upload and Processing Upload Plot Export

Finished configuring device - Success

SeatermUSB - SBE56 V1.8

Exit Refresh Cancel Upload All Report Diagnostics About Help

Connected Devices	Current Configuration	Configuration Options
SBE56 - 2069	Serial Number: 05602069 Firmware Version: SBE56 V0.96 Sample Period (sec): 60.0 Date/Time: 12-Apr-2015 19:3... Start sampling at: 12-Apr-2015 20:0... Current temperature: 25.7943 Events recorded: 0 Battery Changed: 12-Apr-2015 19:3... Number of Samples in Me... 0 Memory Remaining: 30.86 years 100% Calculated battery life remaining: 4.57 years 100% View calibration coefficients	Sample Period: 60 sec <input checked="" type="checkbox"/> Set time to 12-Apr-2015 19:32:00 <input checked="" type="checkbox"/> Clear Memory <input checked="" type="checkbox"/> Clear Events <input checked="" type="checkbox"/> New Battery Installed <input type="checkbox"/> Start sampling on USB cable disconnect <input checked="" type="checkbox"/> Start sampling at 12-Apr-2015 20:00:00 Update Configuration Data Upload and Processing Upload Plot Export

Finished configuring device - Success

SeatermUSB - SBE56 V1.8

Exit Refresh Cancel Upload All Report Diagnostics About Help

Connected Devices	Current Configuration	Configuration Options
SBE56 - 1210	Serial Number: 05601210 Firmware Version: SBE56 V0.96 Sample Period (sec): 60.0 Date/Time: 02-Feb-2015 19:4... Start sampling at: 01-Apr-2015 01:0... Current temperature: 21.9948 Events recorded: 0 Battery Changed: 02-Feb-2015 19:4... Number of Samples in Me... 0 Memory Remaining: 30.86 years 100% Calculated battery life remaining: 4.57 years 100% View calibration coefficients	Sample Period: 60 sec <input checked="" type="checkbox"/> Set time to 02-Feb-2015 19:41:59 <input checked="" type="checkbox"/> Clear Memory <input checked="" type="checkbox"/> Clear Events <input checked="" type="checkbox"/> New Battery Installed <input type="checkbox"/> Start sampling on USB cable disconnect <input checked="" type="checkbox"/> Start sampling at 01-Apr-2015 01:00:00 Update Configuration Data Upload and Processing Upload Plot Export

Finished configuring device - Success

SeatermUSB - SBE56 V1.8

Exit Refresh Cancel Upload All Report Diagnostics About Help

Connected Devices	Current Configuration	Configuration Options
SBE56 - 1211	Serial Number: 05601211 Firmware Version: SBE56 V0.96 Sample Period (sec): 60.0 Date/Time: 02-Feb-2015 21:3... Start sampling at: 01-Apr-2015 01:0... Current temperature: 23.7276 Events recorded: 0 Battery Changed: 02-Feb-2015 21:3... Number of Samples in Me... 0 Memory Remaining: 30.86 years 100% Calculated battery life remaining: 4.57 years 100% View calibration coefficients	Sample Period: 60 sec <input checked="" type="checkbox"/> Set time to 02-Feb-2015 21:34:44 <input checked="" type="checkbox"/> Clear Memory <input checked="" type="checkbox"/> Clear Events <input checked="" type="checkbox"/> New Battery Installed <input type="checkbox"/> Start sampling on USB cable disconnect <input checked="" type="checkbox"/> Start sampling at 01-Apr-2015 01:00:00 Update Configuration Data Upload and Processing Upload Plot Export

Finished configuring device - Success

APPENDIX 3. Stratus 14 Mooring Log.

Correction: anchor drop was 19:58 UTC (or 16:58 local)

Moored Station Log

(fill out log with black ball point pen only)

ARRAY NAME AND NO. Stratus 14 MOORED STATION NO. 1277

Launch (anchor over)

Date (day-mon-yr) 21 - 04 - 2015 Time 16 58 UTC

Deployed by LORD Recorder/Observer GALDRAITH

Ship and Cruise No. AGS61 Cabo de Hornos Intended Duration 1 year

Depth Recorder Reading ~~4488~~ 4510 m Correction Source Sound vel profile

Depth Correction depth from multibeam 1500m SVP profile taken

Corrected Water Depth ~~4488~~ 4510 m Magnetic Variation (E/W) 6.75°

Anchor Drop Lat. (N/S) 19° 49.114 Lon. (E/W) 84° 44.2361

Surveyed Pos. Lat. (N/S) 19° 49.1215 Lon. (E/W) 84° 44.224 ← ship's log

Argos Platform ID No. P2,3 WATCH CIRC 37 AM Additional Argos Info on pages 2 and 3

Acoustic Release Model _____ Tested to 1500 m

Release No. 1 (sn) 33042 Release No. 2 (sn) 33039

Interrogate Freq. 11 Interrogate Freq. 11

Reply Freq. 12 Reply Freq. 12

Enable 314325 Enable 314170

Disable 314340 Disable 314212

Release 332250 Release 332174

Recovery (release fired)

Date (day-mon-yr) _____ Time _____ UTC

Latitude (N/S) _____ Longitude (E/W) _____

Recovered by _____ Recorder/Observer _____

Ship and Cruise No. _____ Actual duration _____ days

Distance from waterline to buoy deck 55 to 60 cm

ARRAY NAME AND NO. Stratus 14 MOORED STATION NO. 1277

Surface Components			
Buoy Type <u>Moss</u> Color(s) Hull Tower _____			
Buoy Markings _____			
Surface Instrumentation			
Item	ID #	Height*	Comments
ASIMET	1		
HRH	303	235	
BPR	234	238	
WIND	344	269	
PRC	504	247	
LWR	219	284	
SWR	216	284	
SST	1839		
PTT	99538		IDS 14644 14652 14653
ASIMET	2		
HRH	250	235	
BPR	213	238	
WIND	205	269	
PRC	218	247	
LWR	503	284	
SWR	215	284	
SST	1725		
PTT	14709		IDS 9805 9807 9811
HRH-SENS	233	243	SENSIRION SENSOR
WXT520	8	252	
LASCAR	10023643	224	
SBE39	5275	228	
SWR-KZ	801		1
XEUSROVER			3004 3406 0447 400
WATCH CIRCLE 3:7 AM *Height above buoy deck in centimeters			

ARRAY NAME AND NO. STRATOS 14 MOORED STATION NO. 1277

Item No.	Length (m)	Item	Depth	Inst No.	Time Over	Time Back	Notes
1		BUOY			1218		
2	.22	³ / ₄ CHAIN					
3		SBE 37	2	1304	1218		
4	.37	³ / ₄ CHAIN					
5		SBE 37	3.7	3821	1219		PRE-ATTACHED TO BRIDLE
6	.525	CHAIN					
7		SBE 35	5	39	1157		
8	.9	³ / ₄ CHAIN					
9		SBE 37	7	3824	1137		
10	4	³ / ₄ CHAIN					
11		SBE 39	12.2	41	1154		
12		AA ADCM	13	235	1154		
13	1.95	³ / ₄ CHAIN					
14		SBE 37	16.4	1899	1150		
15		AA DCP	18.5	1500	1150		HEADS DOWN
16	.675	³ / ₄ CHAIN					
17		SBE 39	20	53	1150		
18	4.05	³ / ₄ CHAIN					
19		SBE 39	25	101	1148		
20	3.97	³ / ₄ CHAIN					
21		SBE 37	30	1900	1144		
22	1.125	³ / ₄ CHAIN					
23		AA ADCM	32.5	238	1140		HEADS UP
24	1.125	³ / ₄ CHAIN					
25		SBE 39	35	721	1140		

ARRAY NAME AND NO. STRATUS 14 MOORED STATION NO. 1277

Item No.	Length (m)	Item	Depth	Inst No.	Time Over	Time Back	Notes
26	3.97	³ / ₄ CHAIN					
27		SBE 37	40	1901	1131		WABARR
28	3.23	³ / ₄ CHAIN					
29		VMCM	45	35	1135		#1 1133 BANDS OFF
30	15.3	⁷ / ₁₆ WIRE					
31		SBE 39	52	1502	1244		
32		SBE 37	62.5	1902	1253		
33	21.2	⁷ / ₁₆ WIRE					
34		SBE 39	70	1509	1256		CLAMPED
35		SBE 39	77.5	1511	1258		"
36		SBE 37	85	8004	1303		
37	1.2	³ / ₄ CHAIN					
38		VMCM	88	2058	1309		BANDS OFF 1304
39	9.5	⁷ / ₁₆ WIRE					
40		SBE 39	92.5	3423	1311		
41		VMCM	100	2068	1318		BANDS OFF 1310
42	28	⁷ / ₁₆ WIRE					SBE BANDS OFF
43		SBE 39	115	3434	1322		
44		SBE 37	130	1903	1327		1326
45	3.3	³ / ₄ CHAIN					
46		RD. ADLD	135	12254	1336		
47	23.5	⁷ / ₁₆ WIRE					
48		SBE 39	145	3435	1341		
49		SBE 37	160	1905	1349		
50	21.3	⁷ / ₁₆ WIRE					

ARRAY NAME AND NO. STRATUS 14 MOORED STATION NO. 1277

Item No.	Length (m)	Item	Depth	Inst No.	Time Over	Time Back	Notes
51		SBE 39	175	3437	1351		
52		VMCM	183	2059	1357		AD. 1350 PROPS SPID
53	4.8	$\frac{7}{16}$ WIRE					
54		SBE 37	190	1907	1403		
55	28.5	$\frac{7}{16}$ WIRE					
56		SBE 37	220	2011	^v 1407		
57	13	$\frac{7}{16}$ WIRE					
58		VMCM	235	61	1417		HANDOFF 1408
59	53	$\frac{3}{8}$ WIRE					
60		SBE 37	250	10	1422		CLAMPED
61		VMCM	290	2010	1428		ASWD @ 1414
62	500	$\frac{3}{8}$ WIRE					
63		SBE 37	310	7836	1438		CLAMPED
64		SBE 39	400	3438	1441		
65		SBE 39	450	3439	1444		
66	500	$\frac{3}{8}$ WIRE			1454-		START TIME FOR THIS START
67	500	$\frac{3}{8}$ WIRE		11237-3	1508-		11237-3
68	180	$\frac{3}{8}$ WIRE		12200-3-A	1527		12200-3-A time over
69	100	$\frac{3}{8}$ WIRE			1528-		WRAPPED TERMINATION
70	200	$\frac{7}{8}$ NYLON			1535-		OVER @ 1543
71	1850	$\frac{7}{8}$ NYLON			21600-		SPLICED
72	1500	1 COLMBIA			1629-		
73		$\frac{84}{8}$ CLASS PAUL			1740- 21841		
74		SBE 37	4496	10600	1854		37m FROM BOTTOM
75		SBE 37	4496	10601	1854		

ARRAY NAME AND NO. STRATUS 14 MOORED STATION NO. 1277

Item No.	Length (m)	Item	Depth	Inst No.	Time Over	Time Back	Notes
76	5	1/2 CHAIN					
77		RELEASE			1904		
78	5	1/2 CHAIN					
79	20	SAMSON					
80	5	1/2 CHAIN					
81		ANCHOR			19:58		
82							
83							
84							
85							
86							
87							
88							
89							
90							
91							
92							
93							
94							
95							
96							
97							
98							
99							
100							

APPENDIX 4. Stratus 13 Mooring Log.

Notes: SST instrument on logger 14 was SBE37#2053. SBE56 in buoy hull at 0 degree orientation (aft) was SN2068 (not 2064).

Moored Station Log

(fill out log with black ball point pen only)

ARRAY NAME AND NO. Stratus 13 MOORED STATION NO. 1265

Launch (anchor over)

Date (day-mon-yr) 07-MARCH-2014 Time 18 01 01 UTC
Deployed by LORD Recorder/Observer GALBRAITH
Ship and Cruise No. ROU BROWN RB14-01 Intended Duration 12 MONTHS
Depth Recorder Reading 5441 ^{4541 ✓} m Correction Source CTD data base
Depth Correction _____ m
Corrected Water Depth 4541 ^{RHB multibeam} m Magnetic Variation (E/W) _____
Anchor Drop Lat. (N/S) 19° 37.9561'S Lon. (E/W) 84° 57.0134'W
Surveyed Pos. Lat. (N/S) 19° 37.4714'S Lon. (E/W) 84° 57.1394'W
Argos Platform ID No. WATCHCIRCLE 3-TAM Additional Argos Info on pages 2 and 3

Acoustic Release Model ORE Tested to 1,500 m
Release No. 1 (sn) 31336 Release No. 2 (sn) 30844
Interrogate Freq. 11K Interrogate Freq. " "
Reply Freq. 12K Reply Freq. 12
Enable 471461 Enable 16647
Disable 471516 Disable 166504
Release 44775 Release 151330

Recovery (release fired)

Date (day-mon-yr) 24-04-15 Time 11:34 UTC
Latitude (N/S) _____ Longitude (E/W) _____
Recovered by LORD Recorder/Observer GALBRAITH
Ship and Cruise No. CADDOCHORNOIS AG361 Actual duration _____ days
Distance from waterline to buoy deck 60

ARRAY NAME AND NO. ^{STATUS 13} 1265 MOORED STATION NO. 1265

Surface Components			
Buoy Type <u>M085</u> Color(s) Hull/Tower <u>BLUE BELOW YELLOW DECK / WHITE</u>			
Buoy Markings <u>IF FOUND ADRIAT CONTACT WOODS HOLE OCEANOGRAPHIC WOODS HOLE NA</u> <u>02543 USA 508 457 1401 50, 60, 70, 80</u>			
Surface Instrumentation			
Item	ID #	Height*	Comments
ASIMET	4		LOGR 5314.11CF
HRH	249	230	
BPR	502	237	
SWND	216	271	
PRC	502	250	
LWR	205	279	
SWR	504	279	
SST	1838		
PIT-ARGOS	12789		WINDCAT, 27916, 27917, 27918
LOGGER	14		
HRH	247	227 230	
BPR	210	267 237	
WIND	239	250 267	
PRC	207	250	
LWR	221	279	
SWR	226	279	
SST			
PIT-ARGOS	18171		27919, 27920, 27921 - WINDCAT
WIND	221	267	
HRH-SENS	214	226	
WXT	1	253	
ASCAR	243	233	
SBE39	1447	234	
XEOS ROVER			300434 060 815 350
*Height above buoy deck in centimeters			

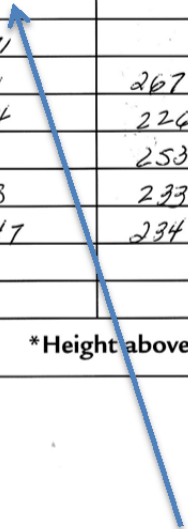

2053

ARRAY NAME AND NO. STRATUS 13 MOORED STATION NO. 1265

Subsurface Instrumentation on Buoy and Bridle			
Item	ID #	Depth†	Comments
WAMDAS	6014	-	
SIS	22		ARGOS BEACON ID 11427
SBE56	2064	90	AFT-0°
SBE56	2065	90	PORT-90
	2066	90	FWD-180
	2067	90	STBD-
PCO2	8		PMEL
SAMI	21		"
SBE16	6566		"
†Depth below buoy deck in centimeters			

3

2068 (not 2064)

ARRAY NAME AND NO. STRAUS 13 MOORED STATION NO. 1265

Item No.	Length (m)	Item	Depth	Inst No.	Time Over	Time Back	Notes
1		BUOY		1148		1913	VARIED DECK 1147
2	.22	$\frac{3}{4}$ " CHAIN					
3		SBE 37	2	1325		1913	
4	.37	$\frac{3}{4}$ " CHAIN					1133.2 MINST attached to 3.2-45m
5		SBE 37	3.7	1326	1127	1931	
6		SBE 39	4.9	35	1127	1931	DOWN
7	1.3	$\frac{3}{4}$ " CHAIN					
8		SBE 37	7	1328	1125	1933	
9	1.73	$\frac{3}{4}$ " CHAIN					
10		NORTEK	10	357	1123	1933	HEAD UP
11	1.35	$\frac{3}{4}$ " CHAIN					
12		RCM 11	13	78	1121	1935	
13	1.5	$\frac{3}{4}$ " CHAIN					
14		SBE 37	16	1329	1121	1935	
15	2.7	$\frac{3}{4}$ " CHAIN					
16		RCM 11	20	79	1119	1945	
17	3.66	$\frac{3}{4}$ " CHAIN SBE 39	2.				
18		SBE 39	25	38	1117	1949	UP
19	3.9	$\frac{3}{4}$ " CHAIN					
20		SBE 37	30	1330	1115	1950	
21	1.12	$\frac{3}{4}$ " CHAIN					
22		RCM 11	32.5	13	1113	1950	
23	1.2	$\frac{3}{4}$ " CHAIN					
24		SBE 39	35	44	1113	1950	
25	3.9	$\frac{3}{4}$ " CHAIN					

ARRAY NAME AND NO. STARS 13 MOORED STATION NO. 1265

Item No.	Length (m)	Item	Depth	Inst No.	Time Over	Time Back	Notes
26		SBE37	40	8211	1110	1959	
27	3.66	³ / ₄ CHAIN					
28		SEAGUARD ADCM	45	138	1108	2002	OPTODE 188
29	16	⁷ / ₁₆ WIRE					1220012 letting go of line
30		SBE39	50	48	1203	2004 1815	
31		SBE39	55	849	1205	1814	
32		SBE37	62.5	8212	1214	1812	
33	23.5	⁷ / ₁₆ WIRE					122007
34		SBE39	70	102	1217	1812	FISHING GEAR WASHED UP. AT VERY TOP OF LINE (SEE FOOT)
35		SBE39	77.5	103	1218	1809	
36		SBE37P	85	1909	1221	1805	STOPPING OFF TO CHECK WIND
37		SEAGUARD ADCM	87.3	140	1312	1804	OPTODE 189
38	18.2	⁷ / ₁₆ WIRE SBE37		203			12200-11
39		SBE39	92.5	203 276	1315	1802	
40		SBE39	100	276	1319	1759	
41		ECOP5	100.5	2866	1319	1759	WETLABS CAP OFF 1317
42		SEAGUARD ADCM	107	961	1324	1756	COND = 726 PRESS 474 474 OPTODE 1072 T-430 BOTH AR
43	21.5	⁷ / ₁₆ WIRE					12200-10
44		SBE39	115	284	1326	1755	
45		SBE37	130	8215	1329	1752	
46	4	⁷ / ₁₆ WIRE					12200-16
47		RDI ADCP	135	1218	1334	1750	UPWARD LOOKING
48	8.5	⁷ / ₁₆ WIRE					12200-19
49		SEAGUARD ADCM	145	141	1337	1748	OPTODE 190
50	13.5	⁷ / ₁₆ WIRE					# 12200 19

ARRAY NAME AND NO. STRATUS 13 MOORED STATION NO. 1265

Item No.	Length (m)	Item	Depth	Inst No.	Time Over	Time Back	Notes
51		SBE 37	160	8212	1341	1744	13200-8
52	21.7	7/16 WIRE					12200-8
53		SBE 39	175	719	1343	1743	
54		SEAGUARD ADCM	183	964	1346	1741	OPTODE 1087 COND 724 PRESS SW 475 T 431
55	5.5	7/16 WIRE					12200-19
56		SBE 37	190	8216	1350	1737	FIRST GOOSE NECK HERE
57	29	7/16 WIRE					12200-6
58		SBE 37	220	8225	1356	1734	
59	13.5	7/16 WIRE					12200-14
60		SEAGUARD ADCM	235	142	1400	1730	MIXED FISHING GEAR HERE OPTODE 267
61	53.5	7/16 WIRE					12200-4
62		OPTODE	250	691	1405	1727 1724	SWAPPED AT RECOVERY
63		SBE 39	280	720 720	1408	1723	
64		SEAGUARD ADCM-0	290	143	1411	1720	OPTODE 268
65	58.5	3/8 WIRE					1207933 FISHING CLINE HERE
66		SBE 37	295	1906	1413	1719	
67		SEAGUARD ADCM-0	350	909	1418	1715	P473 C722 T 429 0 4331088
68	48.5	3/8 WIRE					1024213
69		SEAGUARD ADCM-0	400	144	1424	1710	OPTODE 269
70	48.5	3/8 WIRE					10242-7-A
71		SEAGUARD ADCM-0	450	181	1430	1707	OPTODE 404
72	148.5	3/8 WIRE					12200-17
73		OPTODE	500	913	1434	1706	
74		SBE 37P	550	3733	1440	1702	
75		S.G. ADCM-0	600	182	1446	1658	OPTODE 405 HEADS UP

ARRAY NAME AND NO. STRATUS 13 MOORED STATION NO. 1265

Item No.	Length (m)	Item	Depth	Inst No.	Time Over	Time Back	Notes
76	200	3/8 WIRE					11237-5
77		SBE 37	601	1908	1448	1657	
78		SBE 37	700	8220 8221	1454	1655	SWAPPED SWS @ 2000M UNIT
79		VMCM	802	4	1500	1650	1653 SPUN 1458 BANDS OFF
80	48.5	3/8 WIRE					10242 7.0
81		VMCM	833	31	1504	1645	PROPS 600 1649 SPUN 1503 BANDS OFF
82	500	3/8 WIRE					12200-2
83		SBE 37	857	8218	N1507	1643	
84		SBE 37	81355	8224	1521	1632	
85	150	3/8 WIRE					9074-3A
86		VMCM	1507	32	1528	1625	1405 SPUN 1631 SPIN 1527 PROPS SPUN
87	500	3/8 WIRE			1530	1626 + 1627	12200-1
88		SBE 37	1557	8219	1530	1623	
89		SBE 37	2000	8221 8220	1542	1616	MARKED FOR 700M (SWAPPED)
90		VMCM	2010	42	1548	1609	1405 SPUN 1616 1614 SPIN BANDS OFF 1545 BOTTOM AND REEVE
91	21m 100	3/8 WIRE				1609- 1604	122009 UNIT ADDED, DEEPER LOCATION
92	200	7/8 NYLON			1551-	1601-	15314-8 TERMINATION
93	1000	7/8 NYLON			1605-	1601-	
94	1500	COLMEGA			1630- 1651	1529	
95		88 GLASS BALLS				1335-	TIED ON 1316 2015-4-23 BROKEN OVER AT 17:34
96		PAIR SBE/6	1873 1875		1735	1346	
97	5	1/2 CHAIN RELEASES			1750	1347	
98	5	1/2 CHAIN SAMSON					
99	5	1/2 CHAIN					
100		ANCHOR			1801		

SWAPPED SBE37S @ 700m + 2000m BECAUSE SW 8221 HAD TO HAVE ENDOCAP ADJUSTED

REPORT DOCUMENTATION PAGE	1. REPORT NO. WHOI-2015-03	2.	3. Recipient's Accession No.
4. Title and Subtitle Stratus 14 Fourteenth Setting of the Stratus Ocean Reference Station Cruise On Board RV <i>Cabo de Hornos</i> April 14 - 30, 2015 Valparaiso, Chile		5. Report Date April 2015	
7. Author(s) Sebastien Bigorre, Robert A. Weller, Jeff Lord, Nancy Galbraith, Emerson Hasbrouck, Sergio Pezoa, and Byron Blomquist		6.	
9. Performing Organization Name and Address Woods Hole Oceanographic Institution Woods Hole, Massachusetts 02543		8. Performing Organization Rept. No.	
12. Sponsoring Organization Name and Address National Oceanic and Atmospheric Administration		10. Project/Task/Work Unit No.	
		11. Contract(C) or Grant(G) No. (C)NA14OAR4320158 (G)	
		13. Type of Report & Period Covered Technical Report	
		14.	
15. Supplementary Notes This report should be cited as: Woods Hole Oceanographic Institution Technical Report, WHOI-2015-03.			
16. Abstract (Limit: 200 words) The Ocean Reference Station at 20°S, 85°W under the stratus clouds west of northern Chile is being maintained to provide ongoing climate-quality records of surface meteorology, air-sea fluxes of heat, freshwater, and momentum, and of upper ocean temperature, salinity, and velocity variability. The Stratus Ocean Reference Station (ORS Stratus) is supported by the National Oceanic and Atmospheric Administration's (NOAA) Climate Observation Program. It is recovered and redeployed annually, with past cruises that have come between October and January. This cruise was conducted on the Chilean research vessel <i>Cabo de Hornos</i> . During the 2015 cruise on the <i>Cabo de Hornos</i> to the ORS Stratus site, the primary activities were the recovery of the previous (Stratus 13) WHOI surface mooring, deployment of the new Stratus 14 WHOI surface mooring, in-situ calibration of the buoy meteorological sensors by comparison with instrumentation installed on the ship and CTD casts near the moorings. Surface drifters were also launched along the track.			
17. Document Analysis a. Descriptors Ocean Reference Station Cruise Report Valparaiso, Chile b. Identifiers/Open-Ended Terms c. COSATI Field/Group			
18. Availability Statement Approved for public release; distribution unlimited.		19. Security Class (This Report)	21. No. of Pages 124
		20. Security Class (This Page)	22. Price